

Lecture note on
Water Supply & waste water engg.

Prepared by:- Parthasarathi Sahoo

PTGF of Department of Civil Engg.

Water supply engineering :-

Water is a generous gift of nature, ranks second after air among the most essential requirements of human life to exist.

- It is also the most important element for advancement of society & elevation of standard of living.
- Since, water is a very good solvent, it is nearly impossible to get pure water in nature.
- The various impurities & bacteria caused water borne diseases.
- Hence supply & use of pure potable water is essential.
- The United Nations Environment Project has pointed out the following facts;
 - (i) Water-borne diseases kill 25000 people every day.
 - (ii) 70% of the world population is without safe water.
 - (iii) 80% of the world population is without proper sanitation.
 - (iv) 90% of the people in rural areas are using unsafe water.
- The water supply scheme is to be designed by engineering to solve the population as per their requirement.

Importance of water supply scheme :-

- For any living being, air, food, shelter etc. are the primary key.

- Next to the air the other important requirement for human life is to exist in water.
- Waters are available in various form such as ; River, Lakes, stream etc.
- Every where water is required for various purpose such as ;
 - (i) Drinking & Cooking.
 - (ii) Bathing & Washing.
 - (iii) Watering in Lawn & gardens.
 - (iv) For growing of crops.
 - (v) For fire fighting.

Water treatment :- (Necessity)

Protected water supply means the supply of water that is treated to remove impurities & make save to the public health.

- The water may be polluted by physical & bacterial agent.
- But most of the cities, where unable to collect which laid to water borne diseases.
- This caused necessity of water treatment
- The first type of treatment which was started as filtration of water.

Per capita demand :-

If Q is the total quantity of water required by various purposes by a town per year & P is the population of town then per capita demand will ;

$$\frac{Q}{P \times 365} \text{ lpcd}$$

- Per Capita demand of the town depends on various factors like standard of living, number & type of commercial places in the town.
- For the average Indian town the requirement of water on various uses;

Domestic purpose	135 lpcd
Industrial uses	40 lpcd
Public uses	25 lpcd
Fire fighting	15 lpcd
Losses waste & Theft	55 lpcd
Total	270 lpcd

- The total quantity of water required by the town per day shall be 270 multiplied with the population in litre/day.

Variation of demand :-

Per Capita demand (PCD) of a town is the average consumption of water for a year.

- It varies from season to season even hour to hour.

(1) Seasonal Variation :-

In summer the water demand is maximum, in winter minimum.

(2) Daily variation :-

More water demand will be on Sunday & Holidays due to more comfortable bathing, washing etc. as compare to other working day.

(3) Hourly variation :-

Maximum flow of water 6 A.M - 10 A.M. & 4 P.M - 8 P.M.

→ Minimum flow of water in between 12 P.M - 4 P.M.

Factors affecting per capita demand :-

The factors affecting per capita demand are ;

- (i) Sanitation facilities
- (ii) Cost of water
- (iii) Method of charging
- (iv) Habits of people
- (v) Size of city
- (vi) Pressure in distribution system
- (vii) Quality of water
- (viii) Industries and commercial places
- (ix) Climatic conditions of town.

Methods of forecasting population :-

Following are various methods of population forecasts or population projections & the selection of method will naturally depend on the available data ;

- (1) Arithmetical Increase method
- (2) Geometrical Increase method
- (3) Incremental Increase method
- (4) Graphical method
- (5) Comparative method

- (6) Zoning method
- (7) Ratio and Correlation method
- (8) Growth composition analysis method
- (9) Logistic curve method

A brief description of some of the above method of forecasting population & numerical

will now below ;

(1) Arithmetical increase method :-

This method based upon assumption that population increases at a constant rate i.e. the rate of population with time (i.e. $\frac{dp}{dt}$) is constant.

$$P_n = P_0 + n\bar{x}$$

where,

P_n = ~~P₀~~ Perspective or forecasted population.

P_0 = Population at present / Last decade

n = Number of decades between now & future / years in terms of decades.

\bar{x} = Arithmetic average of increase in population per decade.

$$\bar{x} = \frac{x_1 + x_2 + x_3 + \dots + x_n}{n}$$

$$x_n = P_n - P_{n-1}$$

Ex. of P_0 ; It given 1920, 1930, 1940

→ It is suitable for old & settled communities

<u>Q-1</u>	<u>Year</u>	<u>Population</u>	<u>Per decade increase in population</u>
	1970	40,000	6,000
	1980	46,000	
	1990	53,000	7,000
	2000	58,000	5,000

Find the population using arithmetical increase method at the year of 2010?

Solⁿ:-

$$\bar{x} = \frac{6000 + 7000 + 5000}{3} = 6000$$

$$P_n = P_0 + n\bar{x}$$

$$P_1 = 58,000 + 1 \times 6000 = 64,000$$

(2) Incremental Increase method :-

It is an extension of arithmetic increase method. Here increment over increasing population are added to the arithmetic increase to find the future population.

→ It is progressively increasing or decreasing depending upon whether average of incremental increases is positive or Negative.

$$P_n = P_0 + n\bar{x} + \frac{n(n+1)}{2} \times \bar{y}$$

\bar{x} = Average increase of population of known decades

\bar{y} = Average of incremental increases of known decades

<u>Q-1</u>	<u>Year</u>	<u>Population</u>
	1940	25,000
	1950	48,000

1960 : 55,000

1970 : 6,38,600

1980 : 6,95,200

By using incremental increase method, calculate the population at the year 2000?

Solⁿ:

Year	Population	Increase in population	Incremental increase
1940	25,000		
1950	48,000	23,000	
1960	55,000	7,000	-16,000
1970	6,38,600	88,600	18,600
1980	6,95,200	56,600	-32,000

$$\bar{x} = \frac{23000 + 7000 + 88600 + 56600}{4}$$
$$= 11300$$

$$\bar{y} = \frac{-160000 + 18600 - 32000}{3}$$

$$= -57800$$

$$P_{2000} = 6,95,200 + 2 \times 11300 + \frac{2(2+1)}{2} \times (-57800)$$
$$= 744400$$

$$\therefore P_{2000} = 744400 \quad (\text{Ans})$$

(3) Geometric Increase method :-

This method is based on the assumption per decade percentage increase in the population is assumed to be constant.

dt = Constant

dp = Increasing tremendously

$$P_n = P_0 \left[1 + \frac{r}{100} \right]^n$$

\bar{r} = Geometric average of per decade percentage increase in the population.

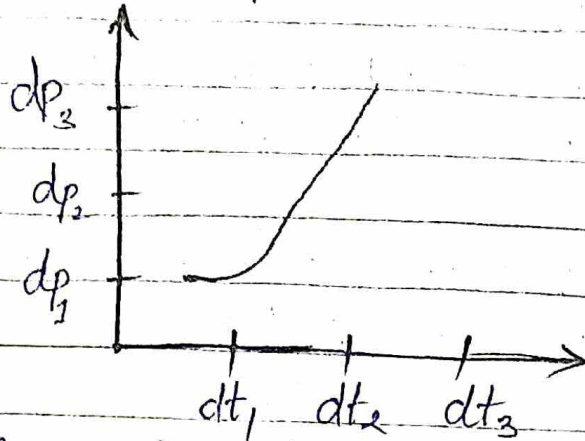

→ In this method the curve is plotted between the time & population.

From known records the curve is obtained & then it is extended according to its nature upto the year in which the population is required to be forecast.

→ This method is most useful.

Q-1 By using Geometric increase method find the population 2020, 2030.

Year	1980	1990	2000	2010
Population	25000	28000	34000	39000

Sol:-

Year	Population	Increase in Population	% of increase
1980	25000		
1990	28000	3000	$\frac{3000}{25000} \times 100 = 12\%$
2000	34000	6000	$\frac{6000}{28000} \times 100 = 21.4\%$
2010	39000	5000	$\frac{5000}{34000} \times 100 = 14.7\%$

Total = 48.12

$$\bar{r} = \frac{48.12}{3} = 16.04\%$$

$$P_{2020} = P_0 + \left[1 + \frac{\bar{r}}{100} \right]$$

$$= 39000 + \left[1 + \frac{16.04}{100} \right]^1$$

$$= 45255.6 \approx 45256$$

$$P_{2030} = 39000 + \left[1 + \frac{16.04}{100} \right]^2$$

$$= 52514.59 \approx 52515$$

$\therefore P_{2020} = 45256$ & $P_{2030} = 52515$ Ans

(4) Decreasing rate of growth method :-

It has been seen that all life grow within limited space. If the complete growth of a very old city is plotted, it will be seen that the curve has S-shape, which indicates that early growth takes place at an increasing rate, latter growth is at a decreasing rate which indicates that saturation limit is reached.

→ In this method, the average decrease in the percentage increase is worked out & is then subtracted from the latest percentage increase for each successive decade.

Arithmetical < Increment < Geometric

Q-1:- year	population	population in	% Increase	Decrease in % increase
1980	25000			
1990	28000	3000	12%	
2000	34000	6000	21.4%	-9.4%
2010	39000	5000	14.7%	+6.7%
			$\bar{x} = 16.04$	$\bar{y} = -1.35$

Net % increase in population;

$$P_{2020} = 14.7\% - (-1.35)$$

$$= 16.05$$

$$P_{2030} = 16.05 - (-1.35) = 17.40$$

$$P_{2010} = 17.40 - (-1.35) = 18.75$$

Population :-

$$P_{2020} = 39000 + \left[\frac{16.05}{100} \right] \times 39000$$

$$= 45259.5$$

$$P_{2030} = 45259.5 + \left[\frac{17.4}{100} \right] \times 45259.5$$

$$= 53134.6 \approx 53135$$

$$P_{2040} = 53135 + \left[\frac{18.75}{100} \right] \times 53135$$

$$= 63097.8 \approx 63098$$

Water Quality :-

Impurities in water :-

The water used for public water supply schemes should be potable i.e. it should be tasty, safe & suitable for drinking & domestic use.

→ It is not possible to find pure water in ~~water~~ nature. The rain water as it drops down to the surface of earth absorbs dust & gases from the atmosphere, that means it contains impurities.

Impurities can be of three types ;

(1) Physical impurities

(2) Chemical impurities

(3) Bacteriological impurities

(1) Physical impurities :-

These are due to the presence of in-organic substances in water.

→ These impurities are not serious as they can be easily detected & removed.

→ Physical impurities are floating matter such as sticks, leaves etc.

→ Physical impurities impart taste, colour, odour and turbidity to the water.

(2) Chemical impurities :-

The chemical impurities may either be of Inorganic type or Organic type.

Inorganic Chemical impurities :- (phosphates, nitrates)

The suspended in-organic chemical impurities are caused by clay, sand, silt etc.

→ Where the dissolved inorganic chemical impurities are caused by minerals & gases in water.

→ The first causes turbidity where as the second causes alkalinity, hardness, acidity, corrosion of metals etc.

Organic Chemical impurities :- (oil, human ^{urine} faeces.)

The suspended organic chemical impurities are caused by the presence of vegetables or animals in the water where as the dissolved organic chemical impurities are caused by vegetables & animals in the water.

(3) Bacteriological impurities :-

Both hardness & harmful bacteria are found in water.

→ The harmful bacteria is known as Pathogenic bacteria or disease creating bacteria & they are mainly responsible for water borne diseases.

→ Therefore these impurities should be carefully investigated.

Harmful effects of impurities in water :-

(i) Makes the water hard in nature.

(ii) Changes chemical nature of water.

- (iii) Quality of water decreases.
(iv) Environmental degradation.
(v) Loss of habitat for fresh water animals.

Analysis of water :-

In order to verify the quality of water for treatment & purification, it is subjected to following test ;

- (a) Physical test
- (b) Chemical test
- (c) Biological test.

(a) Physical test :-

The following tests are conducted to know the physical quality of water:

(i) Colour :-

Due to substances in the true solution or colloidal suspension some colour in water is observed, which produces an undesirable appearance & is objectionable for drinking purposes.

→ This is measure by Tinto meter. (Platinum & Cobalt).

→ The maximum permissible colour for drinking purpose is 20 ppm (Parts per Million-ppm)

(ii) Temperature :-

The desirable temperature of potable water is 10°C , while temperature beyond 27°C is considered to be objectionable.

(iii) Turbidity :-

The suspended inorganic matter like silt, clay etc. imparts turbidity of water.

→ The permissible turbidity for drinking water is 5 ppm - 10 ppm.

→ Turbidity can be measured by turbidity rod (in field condition) & Jackson turbidity ^{meter} (for laboratory condition) is used & Baylis turbidity meter is also used.

→ Jackson measures above 100 ppm turbidity & Baylis measure 5-100 ppm turbidity.

(iv) Taste & Odour :-

The water to be supplied from a public water supply scheme should not contain objectionable taste and odour.

→ The odour is expressed as a number which is called Threshold odour Number (TON).

(b) Chemical Test :-

(i) Total Solids :-

The amount of suspended, dissolved & colloidal solids are determined separately & the added together to get the total amount of solids present in water.

→ This amount should be preferably less than 500 ppm for portable water & it should not exceed 1000 ppm in any case.

(ii) Chloride :-

Specially this test is conducted for sodium chloride of salt.

→ For portable water the amount of chlorides should not exceed 250 ppm.

→ The chloride contents are determined by filtering water sample with standard solution of silver nitrate in presence of potassium chromate indicator.

(iii) Dissolve Oxygen (D.O.) :-

Oxygen in the dissolve state is obtained from atmosphere & pure natural surface water is usually saturated with it.

→ The simple test to determine the amount of dissolved Oxygen present in a sample of water is to expose water for 4 hrs at a temperature of 27°C with a 10% acid solution of potassium permanganate.

→ The quantity of oxygen absorbed can then be calculated.

→ This amount for portable water should be about 5-10 ppm.

(iv) pH value / Hydrogen ion concentration :-

The acidity or alkalinity of water is measured in terms of its pH value or H^+ ion concentration.

→ The pH value of water indicates hydrogen ion concentration in water & is the logarithm of reciprocal of their weights measured in gm/ltr of water.

→ On electrolysis the water is dissociated in two types of ion i.e. positively charged hydrogen ion (H^+) & negative charge hydroxyl ion (OH^-) causing acidity & alkalinity respectively.

→ The neutral water contents equal strength of both acid & alkaline.

→ The pH value for acidic water varies from 0-7.

→ The pH value for alkaline water varies from 7-14.

→ The pH for neutral water is 7.

→ Mostly the fresh water have a pH value of 6-8.

→ For portable water the pH value should be between 7 & 8.5.

→ The pH value of a sample is determined by addition of certain indicator which gives a particular colour.

→ The colour is compared with standard solution of known pH value.

→ In the acidic range the indicators are brown fenel, thynol blue etc. & in the alkaline range these are phenol red, phenol phathaline red.

(V) Hardness :-

The hardness in water is of two types ;

(1) Temporary Hardness

(2) Permanent Hardness

(1) Temporary hardness also known as carbonate hardness which mainly due to the present of bicarbonates of calcium & magnesium.

→ It can be removed by boiling or by adding lime to water.

(2) Permanent hardness is also known as non-carbonate hardness is due to presence of sulphate chlorides & nitrates of calcium & magnesium. It requires special treatment for removal.

→ The hardness is usually expressed as mg/l of calcium carbonate present in water or in terms of degree of hardness.

→ The hardness is usually determined by Sodium Ethylene Diamine Tetra Acetate acid (EDTA) or analytical method.

→ The water with hardness less than 5° is known as soft water.

→ Very soft water is tasteless.

→ Hence for portable water the hardness should preferred be more than 5° but less than 8° .

EDTA (Ethylene Diamine tetra acetic acid)

In this test water is filtrated against EDTA salt solution with erio chrome 'black T' indicator. During filtration colour changes from red to blue. From amount of ~~titration~~ salt absorbed in titration, hardness may be ascertained.

BOD (Bio~~logical~~ Oxygen demand) :-

The demand of oxygen for biological decomposition of sewage under aerobic condition is called BOD.

(c) Biological test :-

The micro biological test of water includes both Bacteriological & Biological test.

(1) Bacteriological test :-

The bacteria are very small organisms & it is not possible to detect them by microscopes.

→ They are detected by circumstantial evidences or chemical reactions.

→ Pathogenic bacteria are harmful to mankind & non-pathogenic bacteria are harmless to mankind.

- Pathogenic bacteria produces intestinal diseases like typhoid, cholera, dysentery etc. (Diarrhea).
- The combined group of pathogenic & non-pathogenic bacteria is designed by bacillus coli (B-Coli group)
- This group of bacteria is present in intestine of all living warm blooded animals.
- Following two standard test are carried out;
 - (i) Total count test
 - (ii) B-Coli test

(i) Total count test :-

In this test bacteria are cultivated on specially prepared medium of agar for different dilution of sample of water with sterilized water.

- The diluted sample is placed in an incubator for 24 hrs. at 37°C or for 48 hrs. at 20°C .
- The bacterial colonies which formed are then counted & the results are computed for 1 cc.
- For portable water the total count should not exceed 100 per cc.

(ii) B-Coli test :-

This test is divided into following three parts ;

- ~~(a) Presumptive test~~ (a) Presumptive test
- (b) Confirmed test
- (c) Completed test

(a) Presumptive test :-

If gas is seen in the tube after maintaining the tube at 37°C for 48 hrs it indicates presence of B-coli group.

(b) Confirmed test :-

A small portion of lactose both showing positive, presumptive test is carefully transferred to another fermentation tube containing brilliant green lactose bile.

- If gas is seen in the tube after 48 hrs. the result is considered positive & the completed test becomes essential.

(c) Completed test :-

This test is made by introducing bacteria colonies into lactose both ~~from~~ a fermentation tube & agar tubes.

- The incubation is carried out at 37°C for 24 or 48 hrs.

- If gas is seen after this period it indicates positive result & further detailed tests are carried out to detect the particular type of bacteria present in water.

(2) Biological test :-

The micro organisms (other than bacteria) in water includes a large variety of algae, fungi, yeasts, protozoa etc.

- The samples are analyzed qualitatively & quantitatively.
- In qualitative test, the sample of net collection, or the original water is examined under the microscope & the genus to which the organisms belong identified & recorded.
- The quantitative examination should be done if the organisms are numerous

to facilitates direct counting, otherwise the organism should be concentrated in a small volume of sample.

Water Quality standards for different uses

Characteristics	Acceptable (mg/l)	Rejection (mg/l)
Turbidity	5	10
Colour	5	25
Taste & odour	Unobjectionable	Unobjectionable
pH	6.5 to 8.5	6.5 to 8.5
Total dissolved solid	500	2000
Total hardness	300	600
Chlorides	250	1000
Sulphates	250	400
Fluorides	1.0	1.5
Nitrates	45	45 (if more than 45 mg/l then blue body disease will occur).
Calcium	75	250
Magnesium	30	100
Iron	0.1	1.0
Manganese	0.1	0.3
Copper	0.05	1.5
Zinc	5.0	15.0
Phenolic compounds	0.001	0.002
Anionic detergents	0.2	1.0
Mineral oil	0.01	0.3
Arsenic	0.01	0.01
Cadmium	0.01	0.01
Chromium	0.05	0.05
Cyanides	0.05	0.05
Lead	0.05	0.05
Selenium	0.01	0.01

Water Supply System

This process consists of supply of purified water to the consumer by appropriate treatment to raw water by conceding its source, intake, pumping.

Need or requirement of water supply

The sanitation of the area is considerably improved by the adequate water supply.

- There is less changes of water born diseases.
- The public in general get purred water.
- It fulfill in general get purred water.

Requirement of Water for different purposes

Water is the most essential commodity for the continuation of life. An adequate & clean water supply is the basic requirement for domestic use for various purposes like—

- (i) for drinking & cooking
- (ii) for bathing & washing
- (iii) for watering of lawns & gardens
- (iv) for air-conditioning system
- (v) For street washing etc.
- (vi) Water is also required for various types of industrial & commercial purposes.

Quantity Of Water

Before designing any water supply Project, first of all the estimation quantity of water is calculated. These calculation based on two factor.

- (i) Rate of demand
- (ii) Population

Rate of demand: The requirement of water for various uses are properly & the rate of

consumption per head is calculated.

Population: The person to be served by the scheme is calculated & estimate the future population.

Rate of Demand

During planning a water supply scheme , it is the duty of the engineer to carefully examine the various types of water demand of the town & then to find out the suitable water sources from where the demand can be met. The various types of water demand of a city or town are:-

- (i) Domestic Water Demand
- (ii) Commercial & Industrial Demand
- (iii) Demand for public uses
- (iv) Fire Demand

Domestic Water Demand:-

- This demand includes the quantity of water required in the houses for drinking, cooking, bathing, washing, gardening, sanitary purposes etc.
- It mainly depends upon the living conditions of the consumer.
- As per IS:1172-1963 water required for domestic purposes for average Indian condition per head per day may be taken as 135 litres.
- In developed countries this may be as high as 350 litres. The total domestic water consumption may amount to 50 to 60% of the total water consumption.

Commercial & Industrial Water Demand :-

- This includes offices, hotels, hospitals, schools, stores, Shopping centres etc.
- This demand depends upon the nature of the city, number and types of industries.
- On an average, 20 to 25% of the total water demand may be allowed for this type of demand in the design.

Demand for public uses :-

- Public demand includes the quantity of water required for public utility purposes such as watering of public parks, gardening, sprinkling on roads, use in public fountains etc.
- In many water supply schemes these demands are not believed as essential and a nominal amount not exceeding 5% of the total demand is kept on arbitrary basis.

Fire Demand :- It is the quantity of water required for fighting a fire outbreak.

For high value cities , water requirement for this purpose is particularly essential.

The quantity of water required for this purpose can be found out by applying certain empirical formula.

These are :-

- (i) National Board of Fire Underwriters Formula :

$$Q = 4637 \sqrt{P(1 - 0.01\sqrt{P})}$$

Where Q = Quantity of water required in litres per minute. P = Population of the town in thousands

(ii) Freeman formula : $Q = 1136.50(P/5)+10$

(iii) Kuichling's Formula : $Q = 3182\sqrt{P}$

(iv) **Buston's** Formula : $Q = 5663\sqrt{P}$

Factors affecting Per Capita Demand :-

The various factors which affect the per capita demand are :-

- 1. Climatic condition :-** Water requirements during summer are more than winter . During summer more water is used for bathing , drinking & also more water is consumed in running coolers etc. Hence water consumption is much more in summer than that in winter.
- 2. Size of city :-** Generally the demand of water per head will be more in big cities than that in small cities. In big cities lot of water is required for maintaining clean & healthy environments while in small towns it is not required.
- 3. Habits of people :-** High class community uses more water due to their better standard of living & higher economic status. Middle class people use water at average rate and for poor people ,a single water tap may be sufficient for several families.
- 4. Industries :-** More water will be required in highly industrialised city .

5. Cost of water :- More costly is the water less will be rate of demand. Hence the cost at which water is supplied to the consumer may also affect the rate of demand.

6. Quality of water :- A water works system having a protected & good quality of water supply would always be more popular with consumers. Hence more quantity of water will be consumed if the quality is good.

7. Pressure in the distribution system :- These would be of great importance in the case of localities having a number of two or three storied buildings. Adequate pressure would mean an uninterrupted and constant supply of water.

8. System of supply :- The system of supply may be continuous or intermittent. In continuous system water is supplied all the 24 hours while in case of intermittent system , water is supplied for certain fixed hours of the day only, result in some reduction in the consumption. This may be due to decrease in losses & other wasteful use.

The chief source of water is rain & it falls on the ground, its certain portion exploit into the ground & another portion is lost by transpiration or evaporation & the remaining portion flows into the river, streams etc.

- The rain water which shocked by the ground forms the sources of underground supplies & the portion which flows in streams forms the sources of surface water supply.
- Thus, it can be divided into two sources;
 1. Surface Sources
 2. Sub-Surface /Underground Sources

1. Surface sources:

The sources of water in which the water flows over the earth surface are called surface sources. The surface sources are mainly classified as; *River, Stream & Lakes, Impounding reservoir.*

- These are formed by rainfall runoff i.e., rain water flowing along the ground into these natural drainage depressions. Quantity varies depending on the catchment.

i. Rivers:

- Rivers are born in the hills, when the discharge of large number of springs and streams combine together.
- Rivers are the only surface source of water which have maximum quantity of water which can be easily taken.

ii. Streams:

- In mountains regions streams are formed by the run off.
- The discharge in streams is much in rainy season than other seasons.
- The quality of water in streams is normally good except the water of first run off.

iii. Lakes:

- In mountains at some places natural basins are formed with impervious beds.
- Water from springs & streams generally flows towards these basins & lakes are formed.
- The quality of water in the lakes depends on its basin capacity, catchment area, annual rainfall & porosity of the ground etc.

iv. Impound reservoirs:

- It may be defined as an artificial lake created by the construction of a dam across a valley containing a water course.
- The object is to store a portion of the stream flow so that it may be used for water supply.

The reservoir consists of three parts:

- a. A dam to hold back water
- b. A spillway through which excess stream flow may discharge.
- c. A gate chamber containing the necessary valves for regulating the flow of water from the reservoir.

2. Underground sources:

These are the sources of water which supply water from below the earth surface.

They include springs, wells & galleries.

i. Springs:

- When ground water reappears at the surface for any reason, springs are formed.
- They serve as source of water supply for small town, especially near hills.
- Some springs discharge hot water due to presence of sulphur & other minerals in their formation.

The various types of springs are;

- a. Artesian springs
 - b. Gravity springs
 - c. Surface springs
- a. Artesian springs :

- In this type of spring, the ground water comes to the surface under pressure.
- The artesian spring may also be formed due to presence of fissure or crack in impervious layer.
- The fissure or crack should be continued up to the ground surface.
- The artesian springs give practically uniform quantity of water throughout the year.

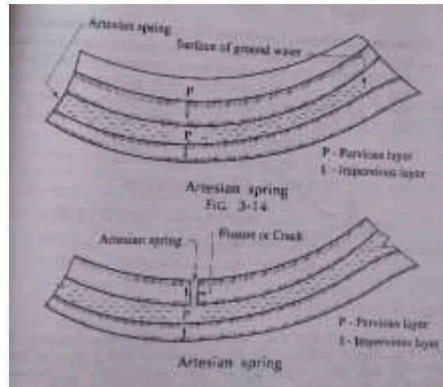

b. Gravity spring:

- This type of spring develops due to overflowing of the water table.
- The flow from a gravity spring is variable with the rise or fall of water table.
- In order to meet with such fluctuation, a trench may be constructed near such a spring.
- The trench acts as a storage reservoir.

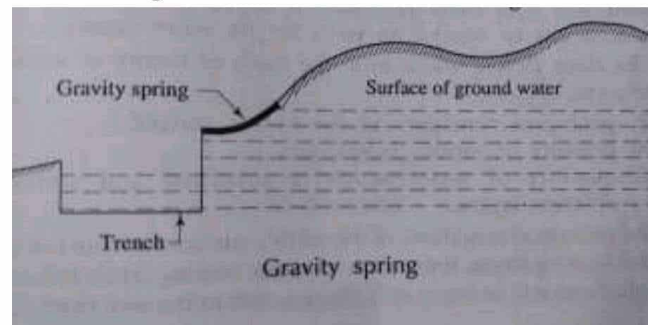

c. Surface springs:

- This type of spring is formed when subsoil water is exposed to the ground surface by the obstruction of an impervious layer.
- The quantity of water available from surface springs is quite uncertain and the cutoff walls, may be constructed to develop such springs.

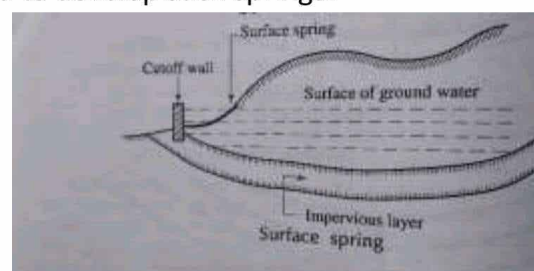

ii. Infiltration galleries:

- An infiltration gallery is a horizontal or nearly horizontal tunnel which is constructed through water bearing strata. It is sometimes referred to as the horizontal well.
- The gallery is usually constructed of brick walls with slab roof.
- The gallery obtains its water from the water bearing strata by various porous drain pipes.
- These pipes are covered with gravel, pebble, etc. so as to prevent the entry of very fine material into the pipe.
- The gallery is laid at a slope and the water collected in the gallery is led to a sump from where it is pumped and supplied to consumers after proper treatment.
- The manholes are provided along the infiltration gallery for the purposes of cleaning and inspection.

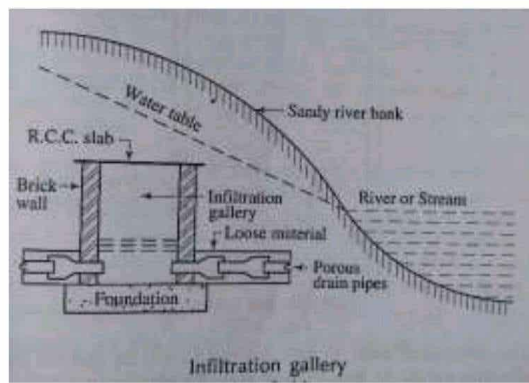

iii. Infiltration wells:

- In order to obtain large quantities of water, the infiltration wells are sunk in series in the banks of river.
- The wells are closed at top and open at bottom.
- They are constructed of brick masonry with open joints .
- For the purpose of inspection of well, the manholes are provided in the top cover.
- The water infiltrates through the bottom of such wells and as it has to pass through sand bed, it gets purified to some extent.

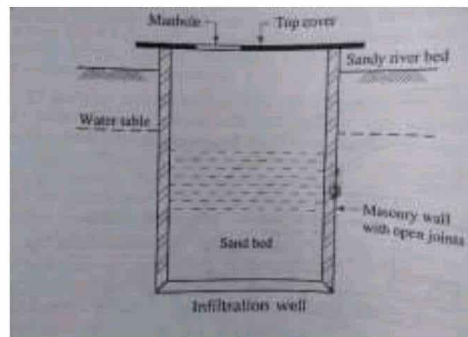

iv. Wells:

- A well is defined as an artificial hole or pit made in the ground for the purpose of water or oil.
- But in general sense a well indicates a source of water, about 70%-80% of Indian population depends on well for water supply.

Wells are generally classified as follows:

- a. Shallow wells
- b. Deep wells & Tube wells
- c. Artesian wells

a. Shallow wells:

- These are wells dug in the upper most layer of earth and obtain their water supply from the subsoil water table.
- The quantity of water available from shallow well is generally limited & hence suitable for water supply in rural areas, for small villages, small towns, isolated buildings etc.
- The quality of water obtain from shallow wells is better than river water but it is not reliable & requires purification.

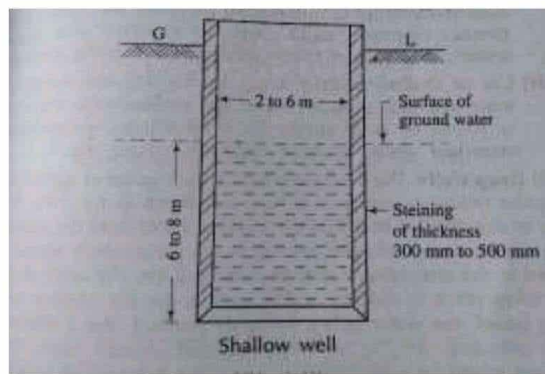

b. Deep wells & Tube wells:

- Deep wells are those which are drilled to an aquifer below an impervious stratum like clay or rock.
- As the water travels a long distance from the source to the site of the well it gets purified due to natural filtrate from soil particles.
- The water is usually hard as it contains dissolved salt in it.
- The tube wells are the deep wells of small diameter 0.15m-1m. The depth may be 60-30m.
- Strainers is provided for the entire depth of the porous stratum to exclude sand & to admit water.
- Maximum discharge of tube well may be about 45 hrs per second.
- The quality of tube well water is generally very good & it many cause it can be used without any treatment.
- However, it is found to possess hardness & it may make it necessary to remove it.
- This is most generally used wherever it is possible.

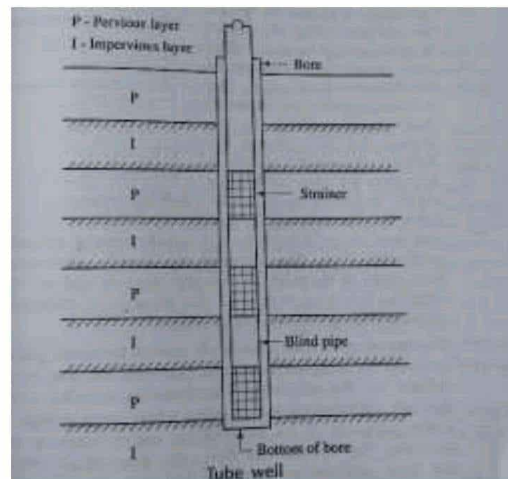
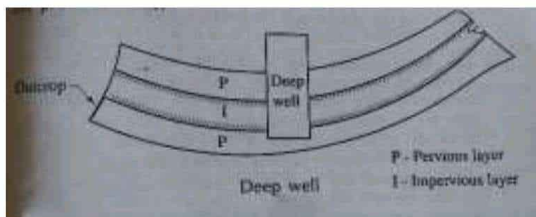

c. Artesian Wells:

- These are caused when pervious stratum is enclosed between the two impervious strata.
- With the formation is so high above the ground that the Hydraulic Great Line (H.G.L.) is above the ground level.
- This is usually form in a valley.
- When the boring is done water comes out with great force.
- No pumping is necessary as per as the hydraulic great line lies above the top level of the well, but when the hydraulic great line goes below the top level of the well pumping is necessary.

(if, $HGL > \text{Ground level}$ pumping not requires)
 $HGL < \text{Ground level}$ pumping requires)

- The quality of water from artesian well is the same as that of tube well water.

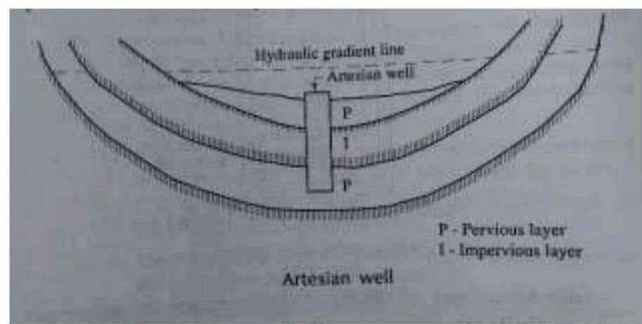

❖ Artesian

Water bearing strata which is sandwich between two hard soil strata.

❖ H.G.L.- Slope of water/gradient of flowing water or stored water on or under the ground.

Yield of well:

It is essential to estimate the quantity of water available from a well, before it is used for water supply purposes.

The term yield of a well is used to indicate the rate of withdrawal or pumping of water from wells without causing failure or drying of wells.

Following are the six factors on which yield of well depends:

- 1) Dimensions of well
- 2) Presence of nearby wells
- 3) Porosity of aquifer
- 4) Quantity of water present in aquifer
- 5) Rate of pumping water
- 6) Slope of water table

When water is pumped from a well the water around the well enters it under the action of head (H-h). This head is known as depression head/percolation head/draw down.

Due to this drawdown, the water table near the well assumes the shape of an inverted cone.

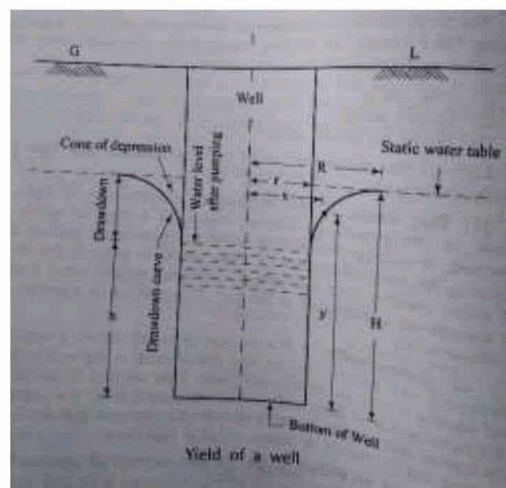

Yield of well;

$$\text{For unconfined aquifer (Q)} = \frac{\pi k(H^2 - h^2)}{2.303 \log_{10} \left(\frac{R}{r}\right)}$$

$$\text{For confined aquifer (Q)} = \frac{2\pi kt(H-h)}{2.303 \log_{10} \left(\frac{R}{r}\right)}$$

Where,

K=Coefficient of permeability (cum/day/m)

Q=Discharge (m^3/day or ltr/day)

R=Radius of influence (m)

r= Radius of well(m)

H=Height of water between static water table and bottom of well (m)

h= Depth of water in well (m)

t= Thickness

Conveyance of water

The term conveyance of water is used to indicate the following two arrangements;

1. Drawing off the water from the sources of water, commonly known as the intakes.
2. Leading the water from intakes to the purification plants and then leading the treated water to the consumers through distribution pipes.

Intakes :

An intake is a structure which is constructed across the surface of water so as to permit the withdrawal of water from the source.

➡ The structure may be of stone masonry, brick masonry, R.C.C. or Concrete blocks.

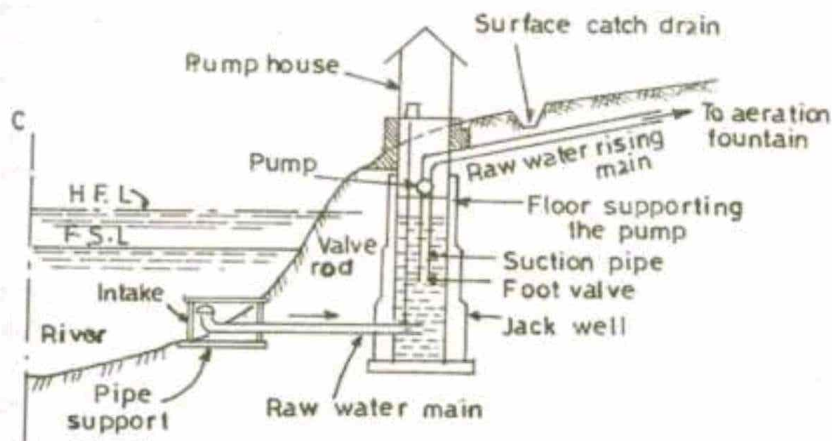

Fig. 4.1

Types of Intakes:-

Intakes are used to collect water for water works from various sources. The sources may be rivers, reservoirs, canals. Common types of intakes are :

- (i) River Intake
- (ii) Reservoir Intake
- (iii) Canal Intake

River Intake (Refer Fig. 4.2) :- It is a circular masonry tower constructed along the bank of river at such place from where required quantity of water can be obtained in the dry period. The water enters in the lower portion of the intake is known as the sump well from penstock. The penstocks are fitted with screens to check the entry of solid and are placed on the downstream side. The opening & closing of penstock valves is done with the help of wheels provided at the pump house floor.

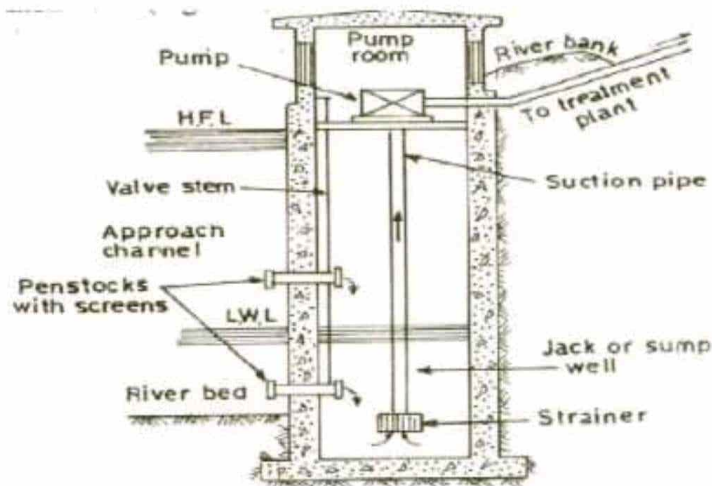

Fig. 4.2 (River Intake)

Reservoir Intakes :- These consists of intake towers having no water inside other than in the intake pipes. The interior of the tower is thus made available for inspection & operation . Fig. 4.3 shows a reservoir intake which is usually located either along the upstream of an earthen dam or within the body of a masonry dam. There are number of inlets protected by screen at different levels to draw in clear water from near the sources.

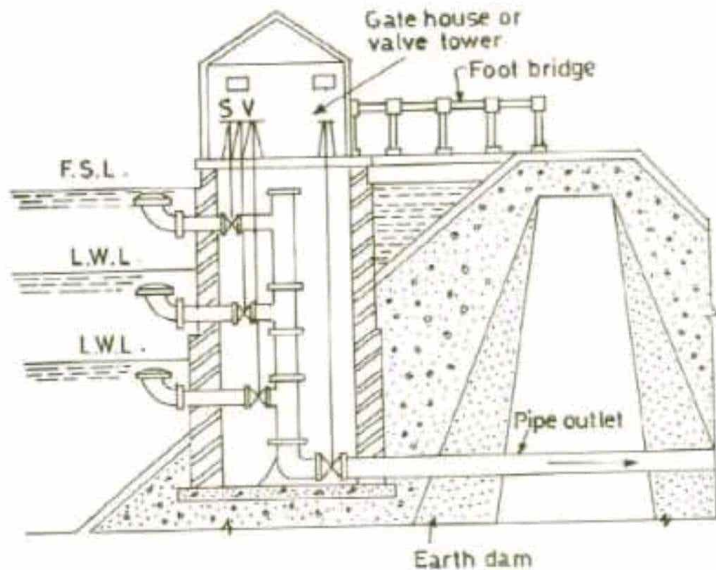

Fig. 4.3 (Reservoir Intake)

When the discharge of some river in summer remains sufficient to meet up the demand , but some rivers dry up partly or fully & can not meet the hot weather demand. In such cases reservoirs are constructed by constructing weirs or dams across the river.

Canal Intake:- Canal Intake is a very simple structure constructed on the bank of a canal & consists of a RCC or brick masonry chamber built partially in the canal bank. Fig 4.4 essentially shows a canal intake. It has a side opening fitted with coarse screen which

excludes heavier matter from entering the conduit. The end of pipe inside chamber is provided with a bell mouth fitted with a hemispherical fine screen. The outlet pipe carries the water to the other side of the canal bank from where it is taken to the treatment plant.

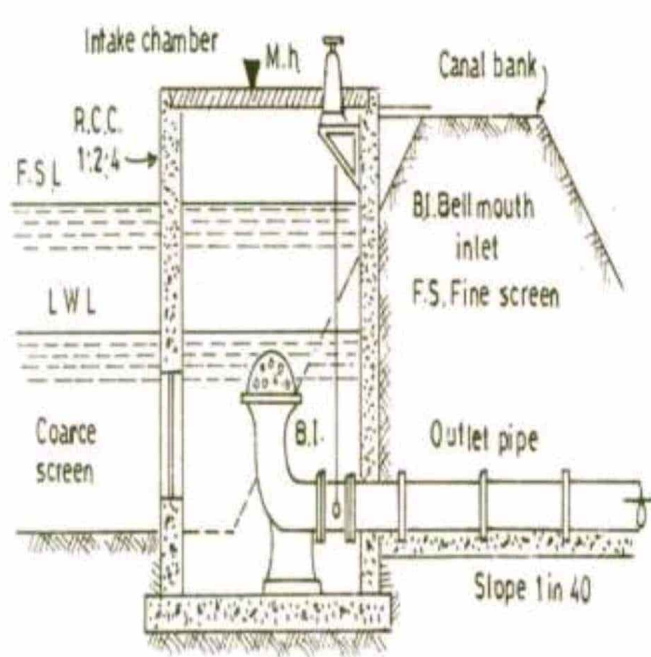

Fig. 4.4 (Canal Intake)

Pumps for conveyance & distribution – types, selection, installation

Pumping

The mechanical process by which the water is covered to flow at increased rate is known as pump & the process using pump is known as pumping.

Necessity of pumps

Following are the purpose for which pumping is adopted;

- ❖ To lift the water to an elevated storage tank.
- ❖ To lift the water from the sources to the water treatment plant.

- ❖ To make available water at higher pressure during certain process of treatment.
- ❖ To throw the water directly into distribution system.

Types of pump;

1. Airlift pump

An **airlift pump** is a pump that has low suction and moderate discharge of liquid and entrained solids. The pump injects compressed air at the bottom of the discharge pipe which is immersed in the liquid. The compressed air mixes with the liquid causing the air-water mixture to be less dense than the rest of the liquid around it and therefore is displaced upwards through the discharge pipe by the surrounding liquid of higher density.

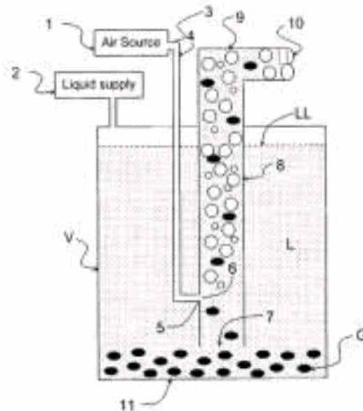

An airlift pump, powered by compressed air, raises fluid by entraining gas to reduce its density.

1. air supply
 2. liquid supply
 3. air inlet port
 4. air supply line
 5. air port
 6. air outlet
 7. fluid intake
 8. riser tube
 9. air liquid mixture
 10. pump outlet
- L: liquid, usually wastewater
LL: liquid level
V: Vessel
G: Gravel or solids.

2. Displacement pump ;

A pump in which liquid is moved out of the pump chamber by a moving surface or by the introduction of compressed air or gas.

Types of positive displacement pump

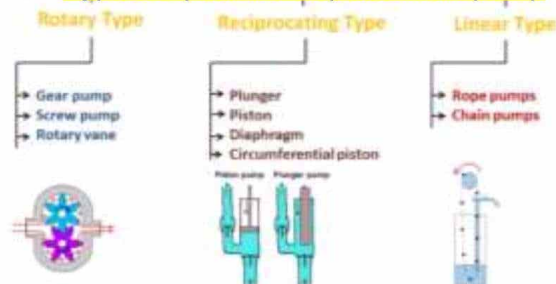

3. Centrifugal pump;

Centrifugal pumps are used to transport fluids by the conversion of rotational kinetic energy to the hydrodynamic energy of the fluid flow. The rotational energy typically comes from an engine or electric motor. They are a sub-class of dynamic axisymmetric work-absorbing turbomachinery. The fluid enters the pump impeller along or near to the rotating axis and is accelerated by the impeller, flowing radially outward into a diffuser or volute chamber (casing), from which it exits.

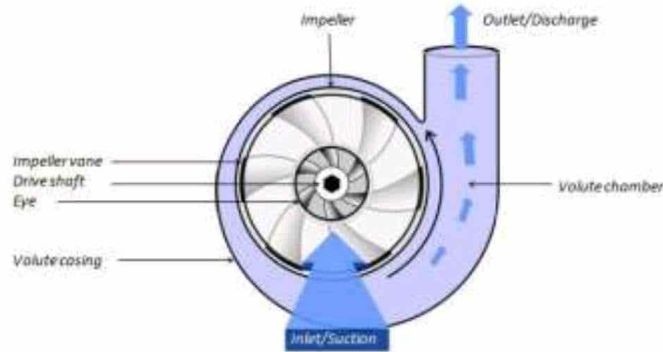

4. Reciprocating pump;

A **reciprocating pump** is a class of positive-displacement pumps that includes the piston pump, plunger pump, and diaphragm pump. Well maintained, reciprocating pumps can last for decades. Unmaintained, however, they can succumb to wear and tear. It is often used where a relatively small quantity of liquid is to be handled and where delivery pressure is quite large. In reciprocating pumps, the chamber that traps the liquid is a stationary cylinder that contains a piston or plunger.

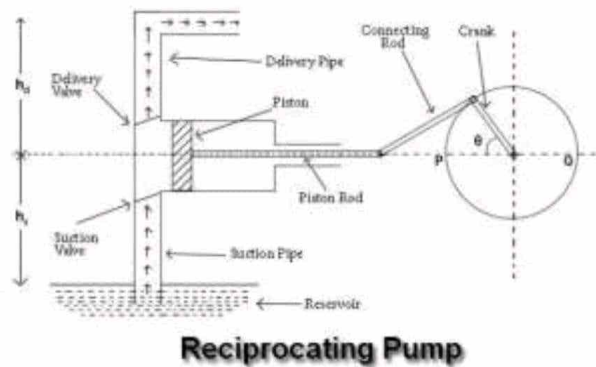

$$\text{Brake Horse Power (BHP)} = \frac{WH}{75E}$$

Where,

W=Weight of water in Kg/sec.

H=Total head in m.

E=Efficiency of pump

PIPES : These are circular conduits in which water flows under pressure .

Now a days the following types of pipes are available :-

- (i) Cast Iron Pipe
- (ii) Steel Pipe & Wrought Iron Pipe
- (iii) RCC Pipe
- (iv) Asbestos Cement Pipe
- (v) Polyvinyl Chloride Pipes

Cast Iron Pipes :- These are most commonly used in water supply scheme due to their durability, strength, resistance to corrosion, easy of laying etc . But the disadvantages of this type of pipes are:-

- (i) Due to its heavy weight, large diameter pipes are difficult to transport in hilly & difficult terrain.
- (ii) Coating inside and outside of the pipe is required for carrying corrosive water.

Steel & Wrought Iron Pipes :- These pipes are stronger than cast iron pipes. They are however less durable having life up to 50 years , more liable to corrosion. To increase the life of wrought iron pipes sometimes these are galvanized with zinc. These pipes can withstand much higher pressure but are of lighter section & hence easy to transport to site .

Advantages of Steel Pipes :-

- (i) Steel Pipes are cheap.
- (ii) These pipes are more durable.
- (iii) These pipes are light in weight , hence easy to transport.
- (iv) These pipes are available in large lengths which decreases the number of joints

- (v) Steel pipes can resist high internal pressure.

Disadvantages :-

- (i) Steel pipes are likely to be rusted which reduces their life.
- (ii) These pipes require more time for repair.
- (iii) The maintenance cost is more.

Reinforced Cement Concrete Pipes :- These are very durable , heavier & can be used up to 1.8m diameter. Transportation costs are much reduced if the pipes are cast- in -situ. These pipes are resistant to corrosion & specially suitable for soft & acidic water. The concrete mix normally used is 1:2:2.

Advantages :-

- (i) These pipes have low maintenance cost.
- (ii) The pipes are not corroded from inside by normal drinkable water.
- (iii) These are very durable.

Disadvantages :-

- (i) These pipes are difficult to repair & join.
- (ii) The pipes have tendency to leak due to shrinkage cracks & porosity.
- (iii) The pipes are difficult to transport.

Asbestos Cement Pipe :- These are manufactured from a mixture of port land cement & asbestos fibre combined under pressure into a dense homogeneous structure. These pipes are very light in weight , can be easily cut, joined & handled. They resist corrosion & are very smooth. Use of these pipes are restricted to minor works of distribution system , because of poor structural resistance to bending stresses caused during transportation.

Advantages :-

- (i) The pipes are very light in weight.
- (ii) The pipes are smooth & their carrying capacities do not reduce with time.
- (iii) The pipes are very suitable as small distribution pipes.
- (iv) The pipes are flexible as such the joints are easily formed.

Disadvantages :-

- (i) The pipes are costly & less durable.
- (ii) The pipes are soft & brittle & do not have much strength.
- (iii) The pipes are likely to be damaged during transportation.

PVC Pipes :- These pipes are widely used for cold water services, rain water system etc. These are strong & can withstand much high pressure for a given wall thickness. It is quite resistance to salt water, corrosive fumes , corrosive soil etc.

Selection of Pipe Material :-

The factors which affect the selection of pipe materials are :

- (i) Internal pressure & external loads to which the pipe is subjected.
- (ii) Type of water to be conveyed & it's resistance to corrosion.
- (iii) Maintenance cost.
- (iv) Availability of fund.
- (v) Expected life & repair & replacement.

PIPE JOINTS :-

The common types of pipe joints are as follows :-

- (i) Spigot & socket Joint
- (ii) Flanged Joint
- (iii) Expansion Joint.
- (iv) Flexible Joint
- (v) Collar Joint
- (vi) Screwed & socket Joint

Spigot & Socket joint (Refer Fig. 4.5):- This type of joint is commonly used in case of cast-iron-pipes. For the construction of this joint the spigot or normal end of one pipe is centred into the socket of the other pipe. Hemp yarn is then wrapped around the spigot, leaving unfilled the required depth of socket for lead. A kneeled clay ring is then placed around the barrel & against the face of the socket. After this molten pig lead is poured into fill the remainder of the socket.

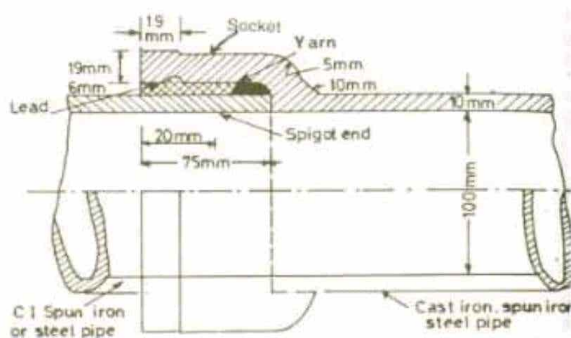

Fig. 4.5 (Spigot & Socket joint)

Flanged Joint (Refer Fig. 4.6) :- These joints are rigid & are easy to disjoint, as such used where pipe joints have to occasionally opened out for carrying out repair work as in pumping chamber. The pipe in this case has flanges on its both ends, casted, welded or screwed with the pipe. A gasket of rubber, canvass or lead is introduced between the two flange of cast iron pipes, which are then tightened with bolts & nuts.

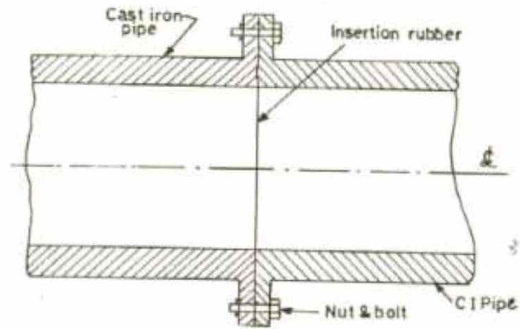

Fig. 4.6 (Flanged Joint)

Expansion Joint (Refer Fig. 4.7) :- These joints are used on pipes exposed to considerable differences of temperature allowing for free expansion or contraction without setting up thermal stresses in the pipes. Here when the pipe expands, the socket end moves forward & when pipe contracts, it moves back word in the space provided for it & the elastic rubber gasket in every position keeps the joint water tight.

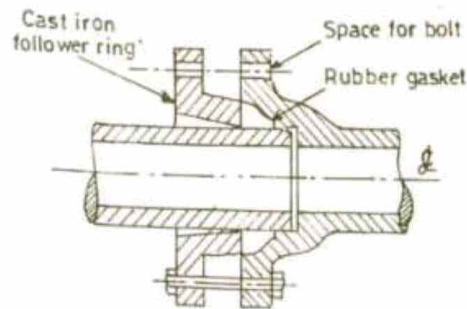

Fig. 4.7 (Expansion Joint)

Flexible Joints (Refer Fig. 4.8) :- These joints are used for pipes to be laid submerged under water, where the bottom of the river is uneven with the possibility of settlement & consequent damage. If one pipe is given any defection, the ball shaped portion will move inside the socket, & the joint will remain water proof in all the position.

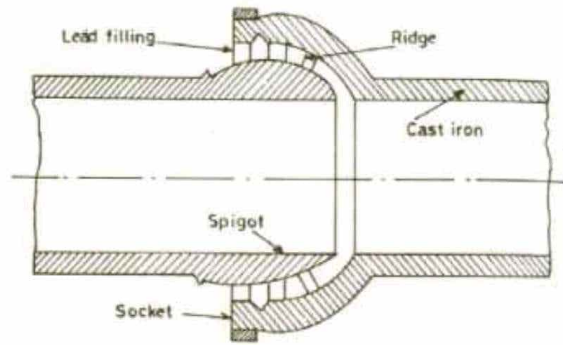

Fig. 4.8 (Flexible Joint)

Collar Joint (Refer Fig. 4.9) :- This joint is mostly used for joining concrete & Asbestos cement pipe having bigger diameter. A rubber gasket is placed between steel rings in the groove after bringing the ends of the two pipes in one level. Then the collar is placed at the joint so that it should have the same lap on both the pipes. After this cement mortar (1:1) is filled in the gap between the pipes & the collar.

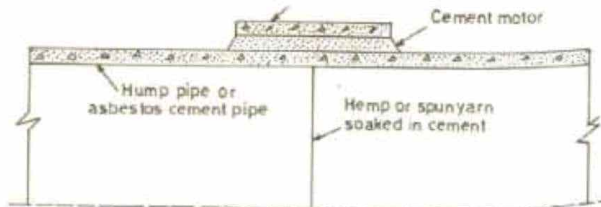

Fig. 4.9 (Collar Joint)

Screwed & Socket Joints (Refer Fig. 4.10) :- This is a simple type of joint commonly used for joining screwed wrought iron or Galvanised iron pipes. In this joint, two ends of the pipes are threaded on the outside and on them a suitable jointing compound should be used before screwing socket over it having corresponding threads from inside.

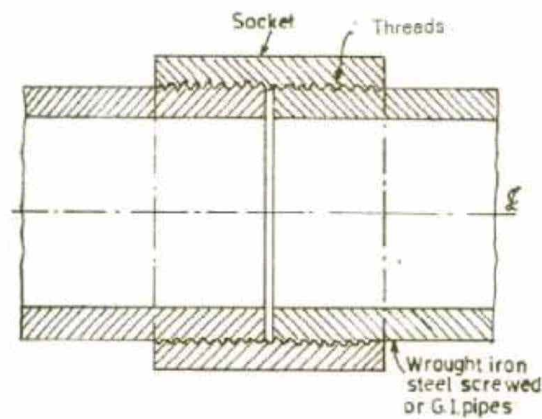

Fig. 4.10 (Screwed & Socket Joints)

Laying of Pipes:-

Pipes are generally laid with a flat slope parallel to the hydraulic gradient to avoid any air locking trouble. Where there is slope, pipe laying should be done in an uphill direction to facilitate joint making.

Testing of Pipe Lines:-

After a new pipe line has been laid & jointed, it shall be subjected to the following two tests :

- (i) Pressure Test
- (ii) Leakage Test

Pressure Test at a Pressure at least double the maximum working Pressure:

The procedure adopted for pressure testing of pipes is as follows :-

- (i) The pipe line is tested from section to section. At a time only one section lying between two sluice valves is taken up for testing.
- (ii) First the downstream sluice valve of the section is closed & water is admitted in the section through the upstream sluice valve. During filling air valve is properly operated to remove all air from the pipe.
- (iii) Then the upstream valve is close to completely isolate the section from the rest of the pipe line.
- (iv) Pressure gauges are then fitted along the pipe length of the section at suitable interval (generally 100 mm or so) on the crown through holes left for this purpose.
- (v) The pipe section is then connected to the delivery side of a pump through a small by-pass valve & the pump is started to increase the pressure in the pipe. The operation is continued till the pressure inside the pipe reaches a pressure at least double of the maximum working pressure.
- (vi) The by-pass valve is then closed & the pump is discontinued .
- (vii) The pipe is kept as it is for 24 hours & inspected for any fall of pressure. This completes the pressure testing of pipes.

Leakage Test at a Pressure to be specified by the authority :-

After successfully completing The pressure test , the leakage test is carried out. Leakage Test is to test maximum allowable leakage which is determined by the formula :

$$Q = (NDP^{1/2})/3.3$$

Where Q = allowable leakage in cm^3/hr

N = number of joints in the length of pipe line

D = diameter in mm

P = the average test pressure during the leakage test in kg/cm^2

Causes of corrosion in water system pipes

Pipes used to distribute drinking water are made of plastic, concrete, or metal (e.g., steel, galvanized steel, ductile iron, copper, or aluminium). Plastic and concrete pipes tend to be resistant to corrosion. Metal pipe corrosion is a continuous and variable process of ion release from the pipe into the water. Under certain environmental conditions, metal pipes can become corroded based on the properties of the pipe, the soil surrounding the pipe, the water properties, and stray electric currents. When metal pipe corrosion occurs, it is a result of the electrochemical electron exchange resulting from the differential galvanic properties between metals, the ionic influences of solutions, aquatic buffering, or the solution pH.

Remedies :-

- Avoid placing of old pipes.
- Avoid placing of rust pipes.
- Control dissolved gases from water which flows through the pipes.
- Rust preventives like lubricants , greases, oils are used to form a protective film to prevent corrosion.

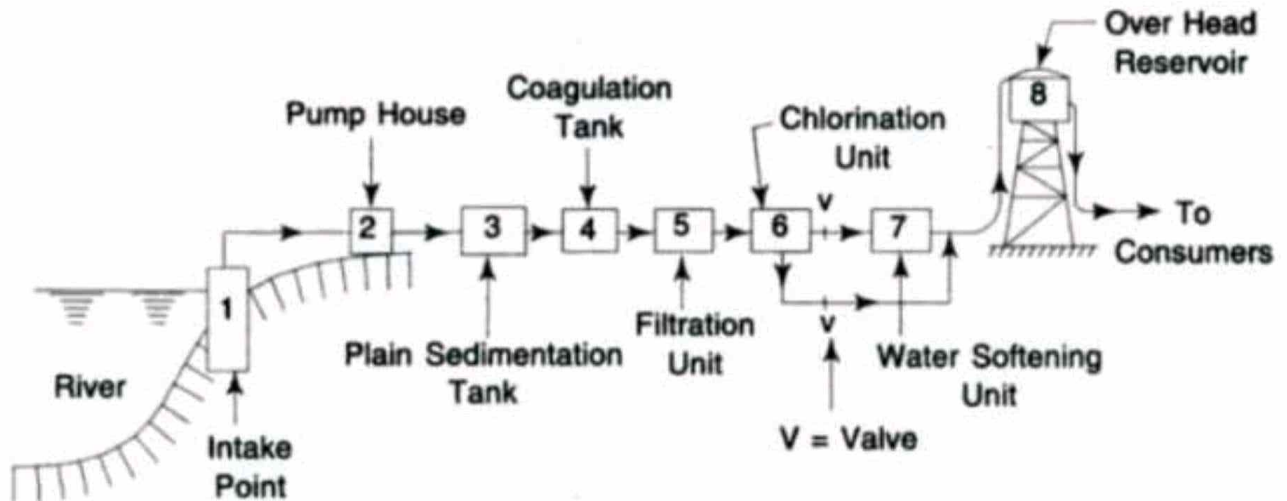

Flow diagram of treatment plant

- 1) Intake point:
The Function of this unit is to collect water in intake well so that water can be supplied throughout the year.
- 2) Pump house:
The function of this unit is to draw water from intake well and to supply same to treatment plant.
- 3) Plain sedimentation tank:
The function of this unit is to remove the heavier suspended particles present in water. In this tank, water is detained for some period or allowed to flow at bottom of sedimentation tank.
- 4) Coagulation tank:
The lighter suspended particles are not removed in plain sedimentation tank by applying some coagulants, after adding of coagulants to water is allowed to flow in coagulation tank in a very low velocity & coagulants make lighter particles to gain settleable size & ultimately settle down at bottom of tank.
- 5) Filtration unit:
The function of this unit is to remove very finer particles which are not eliminated by coagulation tank & some bacteria by filtering media of sand & gravel.
- 6) Chlorination unit:
This unit destroy bacteria by applying chlorine.
- 7) Water softening unit:
The function of this unit is to remove hardness water.
- 8) Overhead reservoir:
The function of this unit to store purified water after treatment is completed by gravity.

Treatment of water

As we know that water from various sources contains impurity & removal of those impurity is essential for supplying portable water to public.

<u>Types of impurities</u>	<u>Treatment required</u>
a. Floating material of big sizes	a. Screening
b. Suspended solids	b. Plain sedimentation
c. Fine suspended solids	c. Coagulation followed by sedimentation
d. Turbidity & colloidal matter	d. Filtration
e. Pathogenic bacteria	e. Disinfection
f. Taste, Odour & colour	f. Aeration & filtration

Screening:

- To prevent the entry of leaves, sticks, large objects, aquatic vegetation, fish etc. screens are provided before pumping in intake water.
- Screens may be placed on vertically or on a light slope.
- It may be coarse or fine.

Aeration:

- Aeration is the process by which air is circulated through, mixed with or dissolved in a liquid or substance.
- Aeration brings water and air in close contact in order to remove dissolved gases and to oxidize dissolved metals, including iron, hydrogen sulphide, and volatile organic chemicals (VOCs).
- This process is typically the first major process at drinking water treatment plant, and occurs in the secondary treatment processes of activated sludge treatment in wastewater treatment plants.

Necessity of aeration:

- to remove carbon dioxide.
- oxidize soluble iron and manganese (found in many well waters) to insoluble precipitates.

Plain Sedimentation:

- The second stage of treatment is plain sedimentation.
- Most of the impurities suspended in water possesses the specific gravity greater than that of water i.e. 1
- These are held in suspension due to turbulence in water.
- When this turbulence is retarded by offering storage to the, the suspended matter tends to settle down at the bottom of the tank.
- Whatever is not taken away by coarse or fine screens is removed by sedimentation which depends upon size of particles, detention period (which is a theoretical time of a setting basin for which the water is detailed in it.), Shape of sedimentation & velocity of flow.
- The particle heavier than water will try to settle down under the force of gravity.
- The velocity of settlement is expressed by stocks law i.e.

$$\left[V = 418(\rho - \rho_1) \times d^2 \times \left(\frac{3T+70}{100} \right) \right]$$

Where,

v=Velocity of settlement in mm/sec.

ρ = Specific gravity of particle

ρ_1 = Specific gravity of water

d = Diameter of particle in mm

T= Temperature in°C

- The above relation does not hold good for particle size $d < 0.1$ mm. so the modified relationship for particle size $d < 0.1$ mm.

$$\left[V = 418(\rho - \rho_1) \times d \times \left(\frac{3T+70}{100} \right) \right]$$

- Plain sedimentation remove 60% suspended matter & 75% bacteria.

Design aspects of setting tank or sedimentation basin or Clarifiers: -

- The setting tanks may be rectangular or square with horizontal flow or circular with spiral or radial flow or hopper shape with vertical flow.
- But in India the rectangular tanks with horizontal flow have been prefer.



Flow horizontal

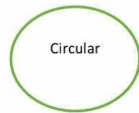

Flow spiral/radial



Flow vertical

Detention:

The theoretical time taken by a particle of water to pass between entry & exit of a setting tank is known as detention period.

$$\left[T = \frac{C}{Q} \right] \text{ or } C=QT$$

Where,

T= Detention period in hrs

C= Capacity of tank

Q= Discharge or rate of flow per hrs

- Normally the detention period vary from 4-8 hrs & when coagulants are used it may vary from 3-4 hrs.
- The depth usually provided for setting tank varies from 3.5-6m.

TYPES OF SEDIMENTATION TANKS (CLARIFIERS)

Depending upon the nature of working, clarifiers are of the following two types:

- (1) Fill and draws type clarifies.
- (2) Continuous flow type clarifies.

(1) Fill & draw a type clarifies:

(i) Working: These are also known as the quiescent type or intermittent type clarifiers. The working of tanks is simple. The water is filled in the tank and it is then allowed to rest for a certain time. During the period of rest the particles in suspensions will settle down at the bottom of the tank. The clear water is then drawn off and the tank is cleared of silt and filled again.

The usual period of rest to cause settlement of particles is about 24 hours or so. If time is required for inlet, outlet, emptying and clearing portion is added a period about 30 to 36 hours is required to put the tank again in working condition.

This means that the least two tanks will be required if an additional unit is to be provided as stand by. The minimum number of tanks required under this type of working will not be less than three.

(iii) Design consideration:

- The cubical contents of the tanks will represent the storage capacity of the tank. The provision is made at the bottom for accumulation of still. The outlet valve is provided at the top of still deposit zone. The inlet and outlet for water are arranged at

opposite ends as seen in plan of the tank fig.1 shows the plan section of a typically fill and draw type of clarifier.

- **USE:**

*These tanks are mostly out of the use at present as they process many disadvantages.

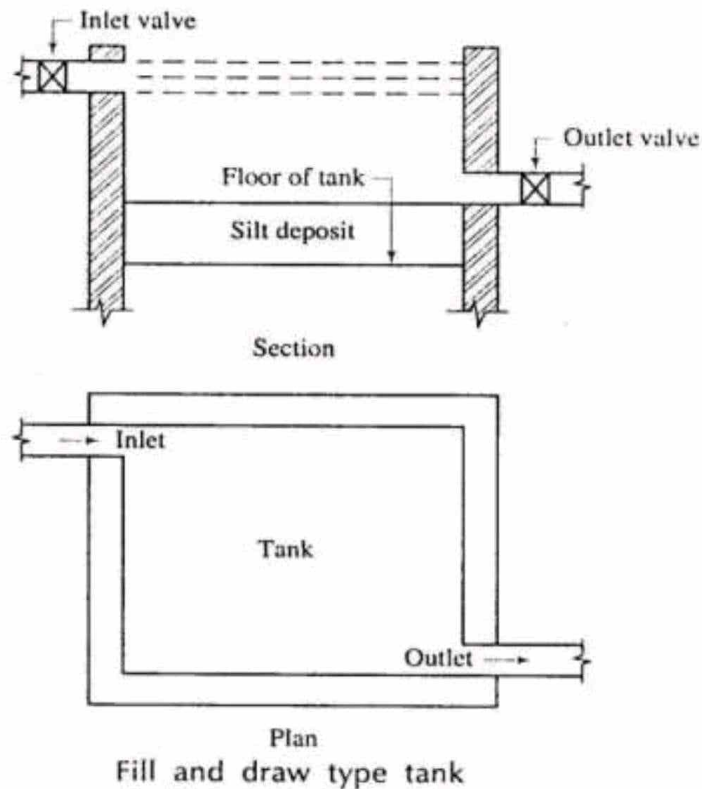

Fig.6.2

(i) If velocity of the flow is reduced a large amount of suspended impurities from water can be easily removed. This is the principle on which continuous floe type of sedimentation tanks is working.

*The working operation of the tank is very simply as illustrated in fig2. The water enters the tank from one end as it travels towards the outlet at the other end, its velocity is broken and reduced by means of baffle walls. The walls contain openings at diffuser level.

*The velocity of the flow is so adjusted that the time taken by a particle of the water to move from one end to the other is slightly more than that required for the settlement of suspended impurities in water.

*The entry of impure water from one end and the exit of clear water from the other end are continuous. The flow of water is designed to meet the following two requirements.

- (a) The velocity of flows is such that suspended impurities of required size settle down at the bottom clarifier.

(b) The total amount of flow from the tank within 24 hours equals to the daily demand of the water.

- The silt is deposited at the bottom of clarifiers and when it is accumulated in sufficient quantity, the flush valve is opened and the clarifier is cleaned.

(ii) USE: These clarifiers are widely used in the modern times as they possess many advantages as mentioned below.

(a) Less labor & supervision:

The action of the sedimentation tank is continuous and hence, no manual labour is required except at the time of cleaning or washing the clarifier. Also only general supervision is required during the working of the clarifier.

(b) LITTLE LOSS OF HEAD:

*The outlet is situated near top of clarifier; there is practically very little loss of head. Also the pure water is drawn from the top level.

(c) TANKS IN SERIES :

*The continuous tanks are arranged in series and hence any one of them may be isolated for cleaning or washing per se. Thus the provision of area for standby units works out to be comparatively less.

(d) TIME OF OPERATION: As the flow of water is continuous, there is no wastage of time, once the tank is put into commission further, no clean water storage tanks will be required and this will result in reduction in cost.

(IV) DISADVANTAGE:

*There is an only one major disadvantage of continuous flows type of clarifiers when the cleaned water in the tanks is to be taken out. Thus there is considerable wastage of water. But cleaning operation are not carried out frequently. Hence such wastage of water can be tolerated.

SEDIMENTATION WITH COAGULATION:

*The turbidity is mainly due to the presence of very fine particles of clay silt and organic matter.

* All these impurities are in a finely divided state & it is not possible to detain them in plain sedimentation tanks unless such tanks are designed longer detention period.

*The other alternative to remove such particles is to increase their size so that they become settleable. The purpose of coagulation is thus to make particles of bigger size by adding certain chemicals known as coagulants to the water. The coagulants react with the impurities in water and convert them in settleable size.

*The coagulation is to be adopted when turbidity of water exceeds about 40ppm.

PRINCIPLE S OF COAGULATION:

The principle of coagulation can be explained from following two considerations.

(1)Floc formation: When coagulants are dissolved in water and thoroughly mixed with it. They produced a thick gelatinous precipitate. This precipitate is known as the floc and thus floc has got property of arresting the suspended impurities in water during its drowned travels towards the bottom of the tank.

(2) Electric charges: The ions of floc are found to posses positive electric charge .Hence they will attract the negatively charged colloidal particles of clay and thus they caused the removal of such particle from the water.

*The surface of floc is sufficiently wide to arrest colloid and organic matter present in water. The term flocculation is used to denoted the process of flock formation and thus the formation and thus the flocculation flows the addition follows the addition of coagulants and its efficiency depends on the

USUAL COAGULANTS :

Following six are the usual coagulants which are adopted for coagulants :

- (1)Aluminum sulphet .
- (2)Chlorinated coppers.
- (3)Ferrous sulphet &lime.
- (4)Magnesium carbonate.
- (5)Polyelectrolyte
- (6)Sodium aluminate.

)ALUMINIUM SULPHATE:

- This is knows the filter alum or alum only. Its chemical composition is $Al_2(SO_4)_3 \cdot 18H_2O$.
- The alum in water treatment practice is commonly supplied and used in the form of flawless or solids lumps and then applied in a solution from.

The advantages of using alum as a coagulant are as follows.

- i. It also reduces taste and odour in water.
- ii. It is cheap.
- iii. It produces crystal clear water

Generally the bicarbonate alkalinity is present in water and the chemical reaction involved between bicarbonate alkalinity and alum is as follows:



The aluminum hydroxide formed is insoluble in water and it behaves as floc.

If water possesses a little or no alkalinity, the lime is added to water. The chemical reaction is as follows. $\text{Al}_2(\text{SO}_4)_3 \cdot 18\text{H}_2\text{O} + 3\text{Ca}(\text{OH})_2 = 2\text{Al}(\text{OH})_3 + 3\text{CaSO}_4 + 18\text{H}_2\text{O}$

This coagulant is found to be effective between PH range of 6.5 to 8.5.

In practices the dosage of alum varies from 5 to 30 milligrams per litre for normal water the usual being 14 milligrams per lit.

The disadvantages of using alum as a coagulant are mainly two.

It is difficult to dewater the sludge formed and further, it is not easy to distance it off also as it is found unsuitable for filling of lying lands.

The effective PH range for coagulation with alum is found to be too small and in some cases, the lime or caustic soda will have to be added to adjust the PH value at a proper level. This will increase the cost of treatment of water.

2) CHLORINATED COPPERAS:-

❖ When chlorine and solution of ferrous sulphate are fixed, the following chemical reaction takes place. $6\text{FeSO}_4 \cdot 7\text{H}_2\text{O} + 3\text{Cl}_2 = 2\text{Fe}_2(\text{SO}_4)_3 + 2\text{FeCl}_3 + 42\text{H}_2\text{O}$

❖ The combination of ferric sulphate $\text{Fe}_2(\text{SO}_4)_3$ and Ferric chloride is known as the chlorinated coppers, each one of the compound is effective as a floc and the combination is also quite effective.

❖ The ferric sulphate and ferric chloride FeCl_3 both can be used independently with lime to act as coagulant and the chemical reactions involved would be as follows.



The ferric hydroxide $\text{Fe}(\text{OH})_3$ forms the flock. For ferric sulphate, the effective PH range is 4 to 7 and above 9. For ferric chloride, the effective PH range is 3.50 to 6.50 and above 8.00.

(3) FERROUS SULPHATE AND LIME:-

❖ When ferrous sulphate and lime are added to the water, the following chemical reaction takes place. $\text{FeSO}_4 \cdot 7\text{H}_2\text{O} + \text{Ca}(\text{OH})_2 = \text{Fe}(\text{OH})_2 + \text{CaSO}_4 + 7\text{H}_2\text{O}$

❖ The ferrous hydroxide $\text{Fe}(\text{OH})_2$ thus oxygen in water and ferric hydroxide is formed as per the following chemical reaction. $4\text{Fe}(\text{OH})_2 + 2\text{H}_2\text{O} = 4\text{Fe}(\text{OH})_3$.

❖ The ferric hydroxide $\text{Fe}(\text{OH})_3$ forms the flock. For ferrous sulphate, the effective PH range is 8.50 and above.

(4) MAGNESSIUM CARBONATE:-

❖ When magnesium carbonate is dissolved and is mixed with water along with lime the following reaction takes place. $\text{Mg} \text{CO}_3 + \text{Ca}(\text{OH})_2 = \text{Mg}(\text{OH})_2 + \text{Ca} \text{CO}_3$.

❖ The compounds magnesium hydroxide $\text{Mg}(\text{OH})_2$ and calcium carbonate are insoluble in water and the sludge formed in this process contains a sludge of $\text{Mg}(\text{OH})_2$ and $\text{Ca} \text{CO}_3$. This coagulant is not at present flavored.

(5) Polyelectrolyte's:-

❖ These are special types of polymers and depending upon the charge they carry, they are classified as anionic, cationic and nonionic only cationic polyelectrolyte's can be used effectively as independent coagulants. The others varieties can be used along with alum or other conventional coagulants.

❖ The use of polyelectrolytes is still in pilot stage and they may prove to be an alternative to the alum in future.

(6) SODIUM ALUMINATE:-

❖ The chemical composition of this coagulant is $\text{Na}_2\text{Al}_2\text{O}_4 + \text{Ca}(\text{HCO}_3)_2 = \text{Ca} \text{Na}_2 \text{Na}_2 \text{Na}_2\text{Al}_2 \text{O}_4 + \text{Na}_2\text{CO}_3 + \text{CO}_2 + \text{H}_2\text{O} \rightarrow (1)$

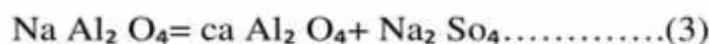

❖ This coagulant5 removes carbonate or tempers or hardness as seen from equation 910 and it also removes non-carbonate or permanent hardness as seen from equation (2) and (3). The effective range of PH value for this coagulant is 6 to 8.5. This coagulant is costly and hence it cannot be adopted for treating water on a large scale.

Mixing Devices:

The success of floc formation mainly depends on the mixing of coagulant with raw water. Following are the six devices which are generally adopted to achieve this purpose;

1. Centrifugal pumps
2. Compressed air
3. Hydraulic jump method
4. Mixing channel
5. Mixing basins with baffle walls
6. Mixing basins with mechanical means

Only one of the mixing device (i.e. Mixing basins with mechanical means) will be now briefly described.

❖ Mixing basins with mechanical means:

- In this method, the mechanical means are used to mix raw water with the coagulant. The usual practice is to achieve quick mixing in, what are known as the flash mixers and then to transfer water from the flash mixer to the slow mixer, known as flocculator.

FLASH MIXERS:-

Flash mixers are used to achieve quickly mixing and then transfer water from the flash mixture to the slow mixture known as flocculator.

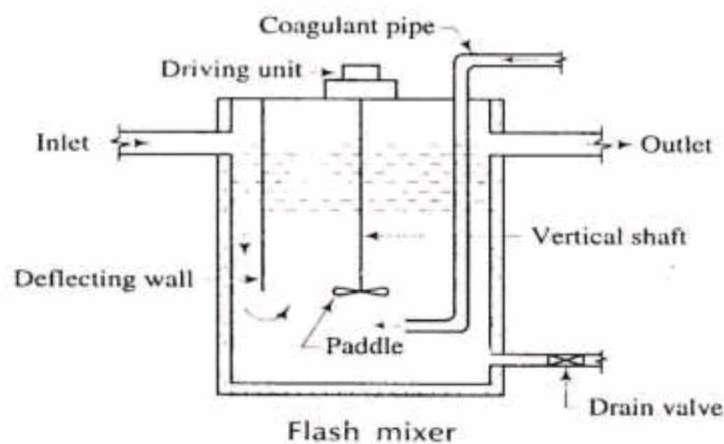

Fig.6.3

Fig.6.3. shows a typical flash mixer. The mixing is achieved by a rotating paddle situated at the lower end of the vertical shaft. The incoming water is deflected toward the moving paddle by deflecting wall.

- ❖ The coagulants are brought by coagulant pipe and also discharge just near the rotating fan.
- ❖ Drain valve is provided to remove sludge from the bottom of flash mixture.

Figure below shows a typical flocculator. The slow mixing is achieved by rotating paddles. The paddles usually make about 2 to 3 revolutions per minute.

Flocculator:

Flocculation is a water treatment process where solids form larger clusters, or flocs, to be removed from water.

- This process can happen spontaneously, or with the help of chemical agents.
- It is a common method of stormwater.

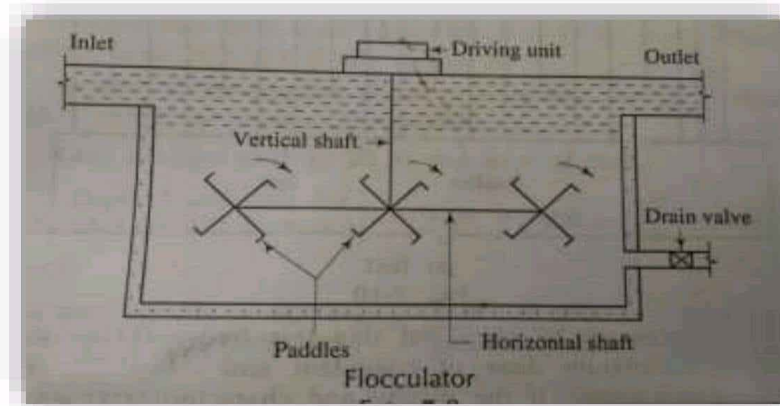

FILTRATION

NECESSITY:

- ❖ The sedimentation tanks remove a large percentage of the suspended solids and the organic matter present in raw water.
- ❖ The process of coagulation further assists in the removal of impurities present in the water. But even then; the resultant water is not pure and may contain some very fine suspended particles, bacteria etc.
- ❖ In order to remove or to reduce the content of impurities still further, the water is filtered through the beds of fine granular material like sand. The process of passing through the bed such granular material is known as filtration.

PRINCIPLES OF FILTRATIONS:

Process of filtration consists of the allowing water to pass through a thick layer of sand.

Principles of filtration are:

(1) **Mechanical straining:** **The** suspended particles which are unable to pass through the voids of sand grains are arrested and are removed by mechanical straining.

(2) **Sedimentation:** **The** voids between sand grains of filter act more or less like small sedimentation tanks. The particles of impurities arrested in these voids, at here to the particles of sand grains and are removed by the action of sedimentation.

(3) **Biological metabolism:**

- ❖ The growth and silt process of the living cells is known as the biological metabolism.
- ❖ When the bacteria are caught in the voids of sand grains, a zoological jelly or film is formed around the sand grains. This film contains large colonies of living bacteria. The bacteria feeds on the organic impurities contained in water. They convert such impurities into harm less compounds by the complex biochemical reaction.

(4) **Electrolytic changes:** According to this theory when two substance with opposite electric charges are brought in to contact with each other, the electric charges are neutralized and in doing so, new chemical substances are formed.

It is observed that some of the sand grains of filter are charged with electricity of some polarity. Hence, when particle of suspended and dissolved matter contain electricity of opposite polarity come into contact with such sand grains they neutral each other and neutralize result in the alteration of chemical characteristics of water.

CLASSIFICATION OF FILTERS :

The filters are classified in to the following:

- (1) Slow sand filter
- (2) Rapid sand filter.

The rapid sand filters are further subdivided into the following two categories.

- ❖ Gravity types rapid sand filter.
- ❖ Pressure type rapid sand filter.

The above classification is based on the rate of filtration. On the consideration of the gravity and pressure the filters may be classified as follows.

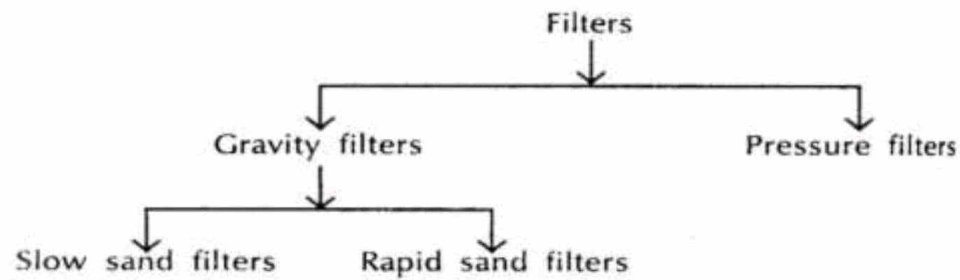

Combining the above two classification, there are following three types of filters.

- 1) slow sand filter
- 2) Rapid sand filter
- 3) pressure filter

SLOW SAND FILTERS:

- ❖ **(1)PURPOSE :** In case of slow sand filtration, the water is allowed to pass slowly through a layer of sand placed above the base of the material and thus the purification process are at simultaneously improving the biological chemical and physical characteristic of water.
- ❖ The slow sand filtration is very well suited for rural areas as in developing countries because of its simple operation and maintenance procedure. It thus provides safe drinking water at low recurrent cost.

ESSENTIAL PARTS: A slow sand filter consists of the following five parts.

- (1) Enclosure tank
- (2) Under drainage system
- (3) Base material
- (4) Filter media or sand
- (5) Appurtenances.

- ❖ **ENCLOSURE TANK:** A water tight tank is constructed either in stone masonry or brick masonry. The sides & floor are also coated with water proof material. The bed slope is about 1 in 100 to 1 in 200 towards the central drain. The depth of tank is about 2.50m to 3.50m. The surface area of a slow sand filter may vary from 30m to 2000m or even more
- ❖ **UNDER DRAINAGE SYSTEM:** The under drainage system consists of a central drain and lateral drain as shown in the fig. 6.4

The lateral drain is placed at a distance of about 2.5 m to 3.5m and they are stopped at a distance of about 500mm to 800mm from the walls of the tanks. The drains may be pipes which are laid with open joint.

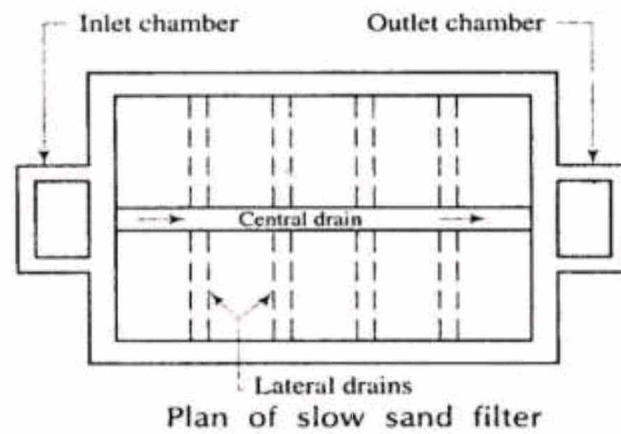

Fig.6.4

(3) **BASE MATERIAL:** The base material is gravels & it is placed on the top of under drainage system .

Its depth varies from 300mm to 750mm .It is usually graded and laid in layers of 150mm .The topmost layer should be small size gravel and the lowest layer should be of bigger size gravel . Followings is a typical section of base material.

Top most layer 150mm depth –size 3mm to 6mm

150mm depth-size 6mm to 20mm

150mm depth –size 20mm to

150mm depth – size 40mm to 65mm

Total 600mm depth.

(iv) FILTER MEDIA OF SAND:

- ❖ A layer of sand placed above the gravels.
- ❖ The depth of sand layer varies from 600mm to 900mm.
- ❖ The effective size of sand varies from 0.20 mm to 0.30mm & the uniformity coefficient about 2 to 3.
- ❖ The finer the sand, the better will be the efficiency of filter regarding the removal of bacteria but in that case , the output from the filter is lowered.

(v) APPURTENANCE:

- ❖ The various appurtenances are to be installed for the efficient working of slow sand filter.
- ❖ The devices for measuring loss of head for controlling depth of water above sand layer. And for limiting rate of flows through filter are to be suitably installed.
- ❖ The vertical air pipe passing through layer of sand help in proper function of filtering layer.

(7) WORKING & CLEANING :

- ❖ The water allowed to enter the filter through the inlet chamber. It descends through the filter media and during this process it gets purified.
- ❖ Water is then collected in the outlet chamber and taken to the clear water storage tank.
- ❖ The depth of water filter is to be carefully decided. It should neither be too small nor too high. Generally it is kept as equal to the height of filter media of sand.
- ❖ For the purpose of cleaning the top layer of sand is scrapped or removed through a depth of about 15mm to 25mm. The water is then admitted to the filter. But the purified water is not taken into use until the formation film around sand grain occurs.

(8) **RATE OF FILTRATION:** - The rate of filtration of a normal slow sand filter varies from 100 to 200 liters/ hours/ m^2 of filter area.

RAPID SAND FILTERS (GRAVITY TYPE): -

- 1) **Purpose:** - The great disadvantages of a slow sand filter are that it requires considerable space for its installation. This requirement makes it uneconomical for places where land values are high.

The difficulty of requiring more space for slow sand filters can be obviated by increasing the rate of filtration which is accomplished in rapid sand filter by increasing the size of sand.

- 2) **Essential parts:** - Fig shows the layout of a typical rapid sand filter (gravity type) . It consists of the following five parts.

i) Enclosure tank

ii) Under drainage system

iii) Base material

iv) Filter media

v) Appurtenances

i) **Enclosure Tank:** A watertight tank is constructed either of masonry or concrete.

- ❖ The side and floor are also coated with waterproof material.

- ❖ The depth of tank is about 2.5m to 3.5m.

- ❖ *The surface area of a exit of rapid sand filter varies from $10m^2$ to $30m^2$.

ii) Under drainage system: There are various forms of under drainage system of a rapid sand filter and most of them are patented by the manufacturers.

*Following are two common types of under drainage system

- a. perforated pipe system
- b. pipe and strainer system

a) **Perforated pipe system:** In this system there is a central drain or manifold and to this manifold the various lateral drains are attached as shown in fig. 6.5

- ❖ The drains are usually made of cast-iron.
- ❖ The lateral drains are placed at a distance of about 150mm to 300mm.
- ❖ The lateral drains are provided with holes at the bottom side and such holes make an angle of 20° with the vertical as shown in fig. 6.5
- ❖ The perforated pipe system is economical and simple in operation.

b) **Pipe and strainer system:** In this system also there is a central drain or manifold with lateral drains attached on either side as shown in the fig. But in this system the strainers are placed on lateral drains instead of drilling holes.

- ❖ A strainer is a small pipe of brass. It is closed at top and contains holes on its surface as shown in fig.6.5
- ❖ The strainers are either screwed or fixed on the top of lateral drains.
- ❖ When pipe and strainer system is adopted the compressed air is used for the purpose of washing the filter. This results in saving of wash water.

Following general rules should be observed in designing the under drainage system: -

- I. The ratio of length of lateral drain to its diameter should not exceed 20.
- II. The cross sectional area of central drain should be about twice the cross sectional area of lateral drain.
- III. The total cross sectional area of perforations should be about 0.20% of the total filter area.
- IV. The cross sectional area of lateral should be about two to four times the total cross sectional area of perforations in it.
- V. The perforations in the lateral drain should be of diameter 6mm to 12mm.
- VI. The spacing of perforation in the lateral drain should vary from 75mm to 200mm center to center.

(iii)**BASE MATERIAL:** The base material is gravel and it is faced on the top of under drainage system.

- ❖ *The gravel to be used for best material should be clean and free from clay , dust, silt and vegetable matter.

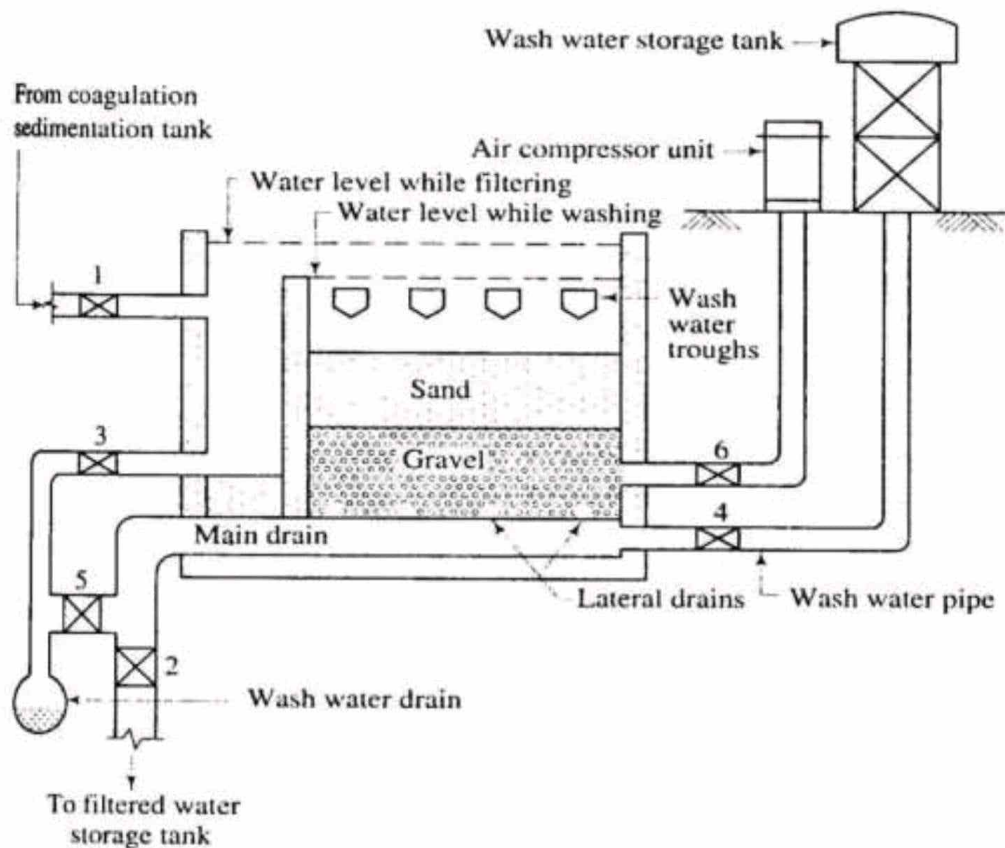

Layout of a typical rapid sand filter (gravity type)

Fig.6.5

- ❖ The gravel particle should be durable, hard, round and strong.
- ❖ The depth of base material varies from 450mm to 600mm gravel. It is usually graded and laid in layers of 150mm.
- ❖ The topmost layer should be of small size of gravel and the lower layer should be of big size gravel.

Following is a typical section of base material:

Top most layer 150mm depth – size 3mm to 6 mm

Intermediate layer { 150mm depth - size 6mm to 12mm
 { 150mm depth - size 12mm to 20mm

Lower layer 150mm depth- size 20 mm to 40mm

Total 600mm depth

(iv) FILTER MEDIA OF SAND: A layer of sand is placed above gravel.

*The depth of sand layer varies from 600mm to 900mm.

* THE coarse sand is used as filter media.

* The effective size of sand varies from 0.35mm to 0.60 mm and the uniformity coefficient

of sand is between 1.20 to 1.70. Thus the space of voids between sand particles is increased and it results in the increase rate filtration.

(v) APPURTENANCES:

a) AIR COMPRESSORS: The agitation of sand grains during washing of filter is carried out either by compressed air or by water jet or by mechanical rakes. When air is to be used an air compressor of required capacity should be installed.

b) WASH- WATER THROUGH: The dirty water after washing of filter is collected in wash water through or gutter which is placed above sand bed level.

c) RATE CONTROL: There are various devices which may be fitted at the outlet end of the filter to control the rate of flow.

3) **Working and cleaning: -**

❖ The working of a rapid gravity filter can be understood by referring to fig. 6.5. The numbers placed near valves indicate the following:

Valve 1 – Inlet valve.

Valve 2 – Filtered water storage tank valve.

Valve 3 – Waste water Valve to drain water from inlet chamber.

Valve 4 – Wash water storage tank Valve

Valve 5 – Waste water Valve to drain water from main drain.

Valve 6 – Compressed air Valve

❖ The Valve 1 is opened and the water from coagulated sedimentation tank is allowed to enter the filter.

❖ The Valve 2 is opened to carry filtered water to the filter water storage tank. All other Valves are kept in closed position. Thus when filter is in working condition only Valves 1 and 2 are in open position.

❖ When the filter requires cleaning or washing it is carried out follows.

I. The Valves 1 and 2 are closed.

II. The Valves 4 and 6 are opened out. The wash water is then forced in the upward direction through the under drainage system, base material and filter media of sand. The compressed air assists the cleaning process of filters.

III. The Valve 6 is closed and the Valve 3 is opened out to carry dirty water through the inlet chamber to the wash water drain.

IV. When washing of filter is over, the Valves 3 and 4 closed and Valve 1 and 5 are opened out. Thus, when filter is put into use after washing, the filtered water in the beginning is led to the wash water drain through main drain. This is continued for few minutes to condition the filter.

V. The Valve 5 is closed and the valve 2 is opened out to put the filter in the normal working condition.

4) **Loss of head and negative head:** - When water passes through the filter it has to resist the frictional resistance. It therefore losses some of its head. The loss of head can easily be computed by knowing the water level in the filter and pressure of water in the outlet pipe. The difference between the two head s indicates the loss of head in filter. In the beginning when the filter is cleaned the loss of head is very small about 150mm. to 300mm. the loss of head then gradually goes on increasing. The loss of head can be measured by inserting piezometers in filter as shown in fig. The difference of water level in two tubes indicates the loss of head.

- A stage then comes when frictional resistance offered by filter media exceeds the static head above sand bed. This is developed due to the deposit of suspended matter in top layer of about 100mm to 150mm. thickness. The lower portion then act more or less like a vacuum and the water is succeed through the filter media rather than flittered through it. The fall of liquid level in the piezometer tube below the center line of under drainage system indicates the negative head.
 - The negative head thus formed tense to release dissolved air and other gasses present in water. The bubbles stick to the sand grains and the working of filter is seriously disturbed. This phenomenon is known as air binding as air binds filter and stops its working. The rate of filtration is consequently greatly reduced.
 - In case of rapid sand filter the allowable loss of head is about 3m. To 3.5m. and the allowable negative head is about 1200mm. The filter is to be washed when this limit of the allowable loss of head has been reached it is usually cleaned after 2 to 3 days.
- 5) **Troubles in operation:** - Following two troubles are generally encountered in operating rapid sand filter.

I. **Mud balls:** - The mud ball are generally formed near the top of filter media. They may even be formed and distributed throughout the filter. The mud balls are formed or caused due to insufficient washing of sand grains. The gelatinous film formed during filtration is not separated out from sand grains

during washing. The mud balls interfere with the normal working of the filter and their size is about 25mm to 50mm.

- II. **Cracking of filters:** - the fine material contained in the top layer of filter shrinks and this shrinkage leads to form cracks in the filter. These cracks are prominent near wall junctions.

To remove these troubles, the following remedies are adopted.

- i. The mud balls are broken with the help of rakes or some such equipment.
 - ii. The working of filters is carried out with high velocity of water.
 - iii. The damaged portion of filter media is replaced.
- 6) **Rate of filtration:** - The chief advantage of a rapid sand filter is that its rate of filtration is very high. It is about 3000 to 6000 liters/ hour/ cm^2 the high rate of filtration results in considerable saving of space for the installation of filter.
- 7) **Efficiency of rapid sand filter:** - The efficiency of rapid sand filter is as follows.
- i. Bacterial load: - The rapid sand filters are less effective in the removal of bacterial load. It is expected that they remove about 80 to 90 percent of bacterial impurity present in water.
 - ii. The rapid sand filters are highly efficient in colour removal and the intensity of colour can be brought down below 10 on cobalt scale.
 - iii. Turbidity: - The rapid sand filter can remove turbidity to the extent of 35 to 45 p.p.m. As water entering rapid sand filter is invariably given the treatment in coagulation sedimentation tank, it possesses less turbidity. This turbidity is brought down easily to the permissible limits by rapid sand filters.

PRESSURE FILTERS: - These filters are more or less similar to the rapid sand filters (gravity type) except with the following differences.

- 1) **Meaning of the term – pressure filter:** - The pressure filter does not indicate that the water is pumped through the filter under a high pressure loss. But it indicates that a filter is enclosed in space and the water passes under pressure greater than atmospheric pressure. This pressure can be developed by pumping and it may vary from 0.3 to 0.7 N/mm^2 .
- 2) **Construction:** - The pressure filters are closed cylinders either riveted or welded. They may be of horizontal or vertical type. The diameters of pressure filters vary from 1.50m to 3.00m. and their lengths or height varies from 3.50m. to 8.00m. the manholes are provided at top for inspection.

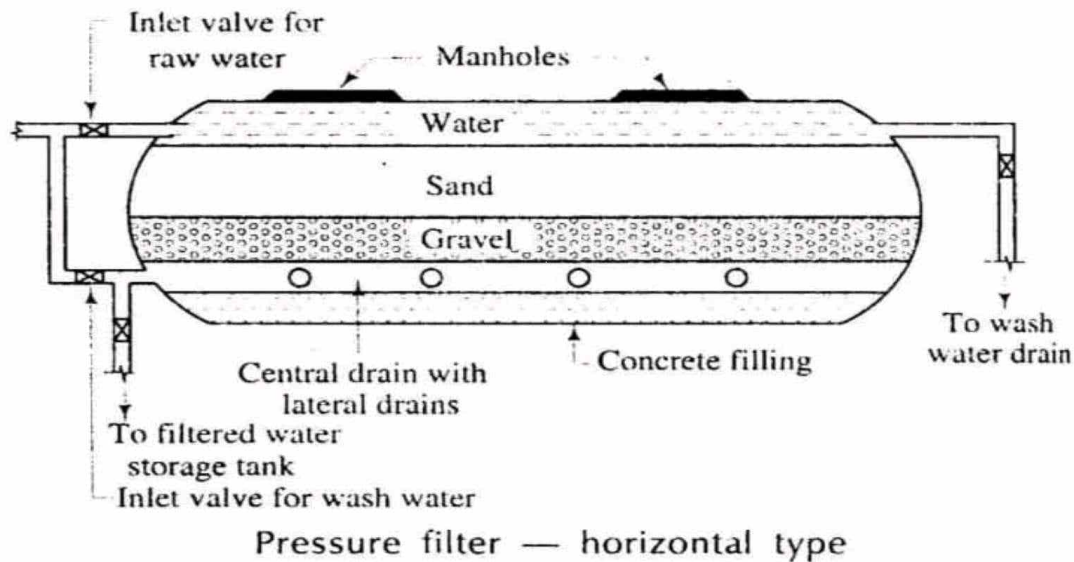

Fig.6.6

- 3) **Working:** - The water mixed with coagulant is directly admitted to the pressure filter. Thus the flocculation takes place inside the pressure filter itself. In normal working condition, all valves are closed except those for raw water and filtered water. The water is admitted through inlet and after it is filtered, it is collected in the central drain and converged to the filtered water storage tank.
- 4) **Cleaning:** - The compressed air may be used to agitate sand grains,
 - ❖ The valves for raw water and filtered water are in closed position and those for wash water and wash water drain are in open position during the operation of washing of filter.
 - ❖ The cleaning of pressure filters may be required more frequently.
 - ❖ The automatic pressure filters are available in which washing of filter is done automatically at a predetermined interval of time or loss of head.
- 5) **Rate of filtration:** - The rate of filtration of pressure filters is high as compared to that of rapid sand filters. It is about 6000 to 15000 liters/hour/m². Of filter area as compared to that of 3000 to 6000 liters/hour/m². Of rapid sand filters.
- 6) **Efficiency:** - The pressure filters are found to be less efficient than the rapid sand filters in terms of bacterial loads, colour and turbidity.
- 7) **Suitability:** - The pressure filters are more suitable for public water supply projects. But they can be installed for small water supply projects such as colonies of few houses, industrial plants, private estates, swimming pools etc.

Disinfection:

The filtered water which still contain pathogenic bacteria, is then made bacteria proof by adding certain chemicals such as Chlorine etc. This process of killing germs called Disinfection.

- The main purpose of disinfection is to prevent contamination of water during its transit from the treatment plant to the place of its consumptions

Necessity of disinfection;

- Disinfection of drinking water and wastewater is critical to the protection of public health.
- All water and wastewater systems should use some form of disinfection process to remove or inactivate microorganisms (pathogens) that can cause disease in humans and animals.
- As water treatment and disinfection are critical to agriculture, cattle, swine and poultry farms, too. All life as we know it thrives on clean water.

Methods of disinfection:

Following are the seven minor methods of disinfection;

1. Boiling method
2. Iodine and bromine treatment
3. Potassium permanganate treatment
4. Ultra-violet ray treatment
5. Excess lime treatment
6. Ozone treatment
7. Silver treatment

1) Boiling method:

- When the water is boiled above a certain temperature, the bacteria are killed.
- The boiling of water is the most effective method of disinfection. But to boil water on a large scale is impracticable.
- However, it will only be sufficient to bring the water to the boiling level and prolonged boiling is unnecessary and wasteful.

2) Excess lime treatment:

- The treatment of lime is given to the water for removal of dissolved salts.
- If excess lime is added to the water, it will also work in addition as a disinfecting material.
- Lime increases pH value of water.
- When this treatment is adopted for disinfection, the excess lime is to be removed by any suitable method of recarbonation after disinfection.

3) Iodine and bromine treatment:

- The dosage of iodine or bromine is about 8 p.p.m. and the contact period with water is about 5 minutes.
- The iodine and bromine are also available in the form of pellets or small pills.
- When used for swimming pools, the bromine residuals are found to be less irritating to the eyes than the chlorine residuals.

4) Ozone treatment:

- The atmospheric oxygen is in molecular form containing two atoms of oxygen. But when a high-tension electric current is passed through a stream of air in a closed chamber, the triatomic molecules of oxygen are formed, such oxygen is known as Ozone.
- The nascent oxygen is very powerful in killing bacteria. The ozone also unites with organic matter and it is thus effective in removal of organic matter also.

5) Potassium permanganate treatment:

- This disinfectant works as a powerful oxidising agent and is found to be effective in killing cholera bacteria. however, it is less effective for other water disease producing organism.

- The use of this disinfectant is restricted to the disinfection of water of village wells and ponds.
 - The water treated with this disinfectant produces a dark brown coating on porcelain vessels and this coating is difficult to remove except with scratching or rubbing.
- 6) Silver treatment:
- The metallic silver is placed as filter media and the water while passing through such a filter absorbs some portion of silver which disinfect the water.
 - The silver treatment does not develop any smell or taste in water and it does not create any harmful effect on human body. But silver is costly.
- 7) Ultra violet ray treatment:
- It is found that the invisible light rays beyond the violet spectrum are very effective in killing all types of bacteria.
 - For the purpose of generating these rays, the mercury is enclosed in one or more quartz bulbs and electric current is then passed through it.

Chlorination:

In this treatment for disinfection, the chlorine (and its compound) is used as the disinfecting material. For treatment on large scale, the chlorination is invariably used as treatment for disinfection.

However, Chlorine is a poisonous gas which requires careful handling and it may also give rise to the problem of taste and odour in water.

Advantage of chlorination;

- i. It accomplishes greater bacterial purification in minutes than storage achieves in an equal number of days. It thus avoids the construction of costly storage reservoir.
- ii. It is inexpensive and avoids, wholly or in part, the necessity for raw water storage.
- iii. It provides extra security to the water against water borne diseases.
- iv. It serves as a convenient accessory to the process of filtration.

Application of chlorine;

- i. As Bleaching powder
- ii. As chloramines
- iii. As free chlorine gas

Forms of chlorination:

Depending upon the stage of treatment at which chlorine is added and also the exposed results of chlorination, the various technical terms of chlorination have come into existence; They are,

- | | |
|------------------------|-----------------------------|
| 1. Plain chlorination | 5. Break point chlorination |
| 2. Pre chlorination | 6. Super chlorination |
| 3. Post chlorination | 7. Dechlorination |
| 4. Double chlorination | |

1) Plain chlorination;

- Only chlorine treatment is given to the raw water.
- The chlorine is added to the raw water to control the growth of algae and to remove bacteria. It also removes organic matter and colour from water.
- Such type of treatment is useful when the raw water is sufficiently clear or in case of emergencies such as supply of water to the armies.

➤ The quantity of chlorine to be added to the raw water is about 0.50 p.p.m. or more.

2) Pre chlorination:

➤ When chlorine is added to the raw water before any treatment, it is known as Pre chlorination.

➤ Thus, chlorine is added in small amount before raw water enters sedimentation tanks.

3) Post chlorination:

➤ This term indicates the application of chlorine after all the treatments of purification of water are completed.

➤ This is the standard treatment and chlorine is added to the water after it leaves rapid sand filters and before it enters distribution tank.

4) Double chlorination:

➤ When chlorine is added to the raw water at more than one point, it is known as the double chlorination.

➤ When raw water is highly contaminated and contains large amount of bacterial life, it becomes necessary to adopt pre chlorination and post chlorination of such water.

5) Break point chlorination:

This term has come into practical use to refer the amount of chlorine required to treat the water.

If water is pure and if it has no chlorine demand, any chlorine that is added to such water will come out as **residual chlorine**.

But for water containing organic matter, the chlorine has perform following two function;

- i. To remove bacteria from water
- ii. To oxidise the organic matter present in water.

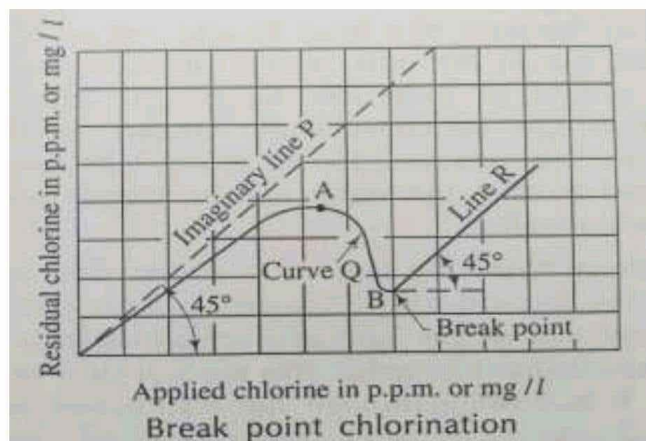

Initially when chlorine added to water, it performs function of removing bacteria from water as represented by the first part of curve. Then it starts to accumulate up to "A". At this stage if further chlorine added in water, then followed by a decrease in residual chlorine content. Here extra quantity of chlorine is added after point A has been utilized for 2nd function of chlorine.

It still furthers chlorine added in water point B reached then bad smell & taste suddenly disappear & residual chlorine hence forth tends to accumulate represented by line R know as no demand curve. The point B on curve Q know as break point & corresponding chlorination called "Break point Chlorination".

6) Super chlorination:

➤ The application chlorine beyond the stage of break point is known as the super chlorination.

➤ The super chlorination is adopted when there is epidemic in the locality and the water is likely to contain a high content of organic impurities.

- When super chlorination has been practised, it becomes necessary to remove the excess chlorine by any suitable method of dichlorination before water sent for consumption.

7) Dechlorination:

- The removal of excess chlorine from water is known as the dechlorination.
- The dichlorination should be done in such a way that at the end of dechlorination process, some residual chlorine remains in water.
- This residual chlorine will disinfect water when it is flowing the distribution system.

Water Softening:

- Hardness removal is called water softening.
- In addition to these, softening increases the efficiency of filtration, aids in the removal of colour, iron and manganese, makes possible the production of non-corrosive water, improves the cooking of foods and increases the efficiency of reduction of bacteria when filtration follows softening.
- Water must be reduced to zero hardness before soap will become effective as a detergent.

Necessity of water softening:

- Water softening is an important process, because the hardness of water in household and companies is reduced during this process. When water is hard, it can clog pipes and soap will dissolve in it less easily. Water softening can prevent these negative effects.
- Protect our home & plumbing incorporating soft water into our home is not just good for us.
- Clean more efficiently.
- Help protecting the environment.

Removal of temporary hardness:

Temporary hardness can be removed by,

- Boiling
- Adding lime

Boiling method is not suited for large scale, Hence Second method is adopted.

Methods of softening:

Permanent hardness is removed by one of the following methods;

- Lime soda process
- Zeolite process
- Deionization process

a. Lime soda process:

- Addition of lime reduces only the bicarbonate hardness.
- By addition of lime and soda as (Na_2CO_3) both the temporary and permanent hardness can be removed.
- The method is therefore known as lime soda process, in which lime, and soda are added to the raw water either separately or together.
- The process involves the through mixing of the chemicals with water, followed by slow agitation for 30 to 60 minutes, to allow completion of chemical reaction.

- Precipitated chemicals are removed by sedimentation or filtration or both
- Lime soda process may be operated continuously or intermittently either cold or hot.
- The aim of the lime soda process is to make the calcium and magnesium content of the hard water to take their insoluble form so that they precipitate out.

Advantage of lime soda process;

- i. The process is more economical.
- ii. The process is free from patent completion.
- iii. This process is suitable for turbid, and acidic waters where zeolite process cannot be used.
- iv. The process can be easily added to an existing filter plant of any water supply scheme.
- v. The process increases the pH value of the water, which results in decrease in corrosion of the distribution system.

Disadvantages of lime soda process;

- i. A large quantity of sludge is formed in this process and hence there are problems of its disposal.
- ii. The process requires skilled supervision.
- iii. It is not possible to produce zero hardness by this process. However, zero hardness is seldom required.

b. Zeolite process:

- Zeolite process also known as the base exchange or ion exchange process, in which no such chemicals are added to water.
- Instead, hard water is placed through a bed of a special material loosely called the Zeolite, which has property of removing calcium & magnesium from the water substituting sodium in their place by ion exchange phenomenon.
- Zeolite are complex compound of aluminium, silica and soda, some of which are synthetic and others are naturally occurring.
- Natural zeolites are mainly produced from green sand (Glaucanite). It is in colour and has an exchange value of 6500 to 9000 gm hardness per m³ of zeolite.
- The common artificial zeolite is permutit. It has larger grains and its colour is white. Its chemical formula $\text{SiO}_2 \text{Al}_2 \text{O}_3 \text{Na}_2\text{O}$.
- Similar reaction take place with compounds of magnesium. The effect is to reduce hardness almost to zero.

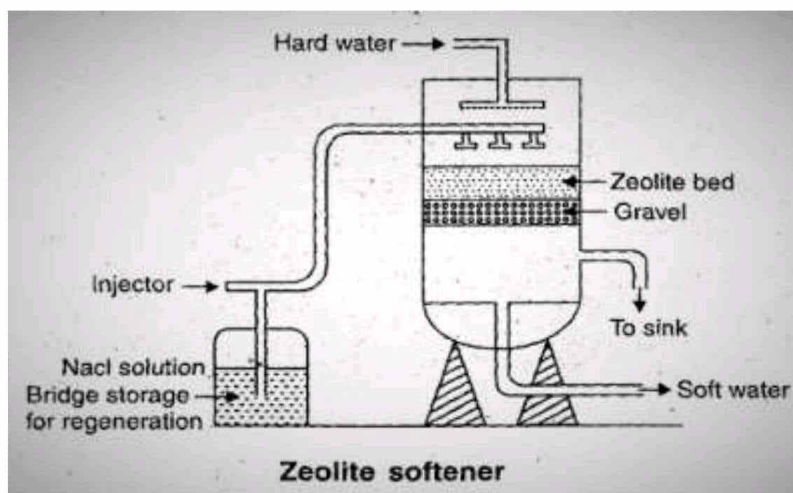

Regeneration of zeolite process;

- Due to continuous use of the zeolite, the sodium present in it is exhausted.
- At the stage zeolite is regenerated by passing a solution of salt (in the form of brine solution) through it.
- The sodium in the brine replaces the calcium and magnesium in the exhausted zeolite, which is thus restored, and the calcium and magnesium are discharged to waste water with the wash water.
- The zeolite is now ready for use for softening more water.

Advantages of zeolite process;

- i. No sludge is formed, and hence there are no problems of sludge disposal.
- ii. The zeolite unit is compact and hence small space is required.
- iii. The unit can be easily operated. High skilled labour is not required.
- iv. The first cost of the unit and the operating cost are low.
- v. The process is almost automatic.
- vi. The process is free from danger of excess chemicals in the effluent, since no chemicals are added to water.
- vii. The process is independent of the change in the quality of raw water.

Disadvantages of zeolite process;

- i. The method is unsuitable for highly turbid water, since suspended particles get deposited around the zeolite particles.
- ii. The process is unsuitable for water containing iron and manganese.
- iii. The process is unsuitable for acidic waters.
- iv. Zeolite softener should be operated carefully to avoid injury to the zeolite, to the equipment or to the quality of the water.
- v. There is likelihood of growth of bacteria on the bed of zeolite. It should therefore be flushed annually with chlorinated water.

c. Deionization process:

- i. The method of softening is cations exchange process.
- ii. The demineralization process is too costly for municipal water.
- iii. However, it has been found useful for manufacturing soft drinks and in industrial process where water free from mineral salts is required.
- iv. However, the water to be treated should have turbidity of less than 5 to 10 ppm.

Ion Exchange method:

- Ion exchange is the oldest and most common method of water softening.
- Generally, it entails exchanging the magnesium and calcium ion contained in hard water for sodium ions.
- Since each calcium and magnesium ion has a positive charge of 2, each ion is exchanged for two sodium ions.
- The sodium ions mostly come from a brine solution, with the displacement of sodium taking place due to the more powerful charge of magnesium and calcium.
- The exchange therefore frees water of free magnesium and calcium ions, making the water soft.

ION EXCHANGE PROCESS

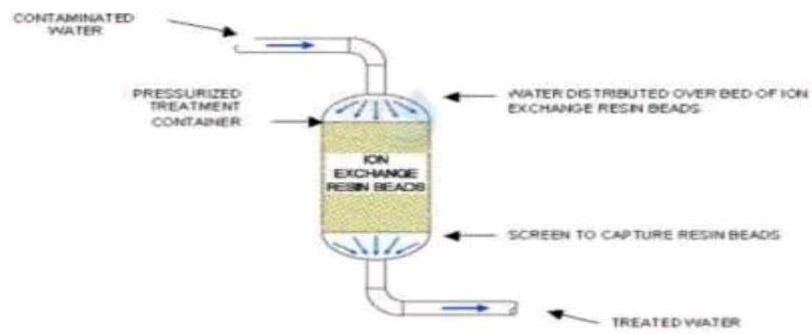

The ION Exchange Process in Water Softening

DISTRIBUTION SYSTEM

GENERAL

After complete treatment of water, it becomes necessary to distribute it to a number of houses, estates, industries and public places by means of a network of distribution system. The distribution system consists of pipes of various sizes, valves, meters, pumps, distribution reservoirs, hydrants, stand posts etc. The pipe lines carry the water to each and every street, road. Valves control the flow of water through the pipes. Meters are provided to measure the quantity of water consumed by individual as well as by the town. Hydrants are provided to connect the water to the fire fighting equipments during fire. Service connections are done to connect the individual building with the water line passing through the streets. Pumps are provided to pump the water to the elevated service reservoirs or directly in the water mains to obtain the required pressure in the pipe lines.

The following are the requirements of a good distribution system:

- (i) It should convey the treated water up to the consumers with the same degree of purity.
- (ii) The water should reach to every consumer with the required pressure head.
- (iii) Sufficient quantity of treated water should reach for the domestic and industrial use.
- (iv) The distribution system should be economical and easy to maintain and operate.
- (v) It should be able to transport sufficient quantity of water during emergency such as fire-fighting.
- (vi) It should be reliable so that even during breakdown or repairs of one line water should reach that locality from other line.
- (vii) During repair work, it should not cause obstruction to the traffic.
- (viii) It should be safe against any future pollution. The pipe lines as far as possible should not be laid below the sewer lines.
- (ix) The quantity of the pipes laid should be good and it should not burst.
- (x) It should be water-tight and the water losses due to leakage should be minimum as far as possible.

METHOD OF DISTRIBUTION

Depending upon the topography of the country, any one of the following three methods may be adopted for the distribution of water.

1. **Gravity system:** - In this system the water is conveyed through pipes by gravity only. The gravity system is the most reliable methods of distribution. But it is useful only when the source of water supply is situated at a higher level than that of distribution area. Fig.7.1 shows the gravity system with hydraulic gradients during maximum and minimum demands. In case of a fire, the motor pumps may be used to develop high pressure for fire fighting purpose.

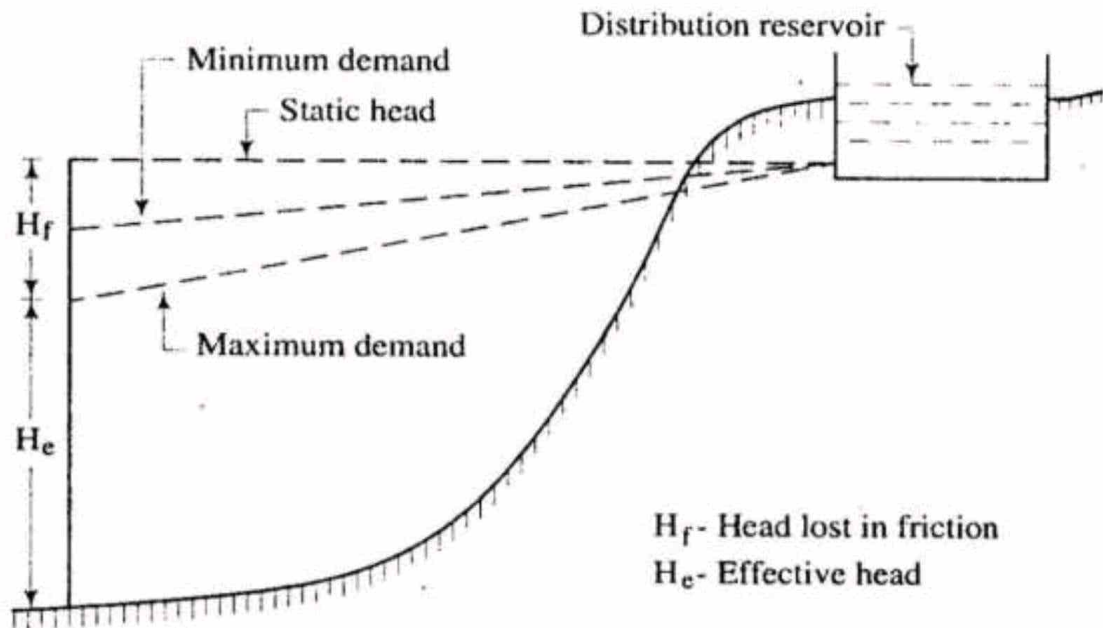

Gravity system

Fig.7.1

2. **Gravity and pumping system combined:** -In this system, the treated water is pumped and stored in an elevated distribution reservoir. The excess water during low consumption remains in the elevated reservoir and it is supplied during the peak period. The pumps are generally worked at constant rate and this rate of pumping is so adjusted that the excess quantity of water stored in reservoir during low consumption is nearly equal to the extra demand of water during peak period. Fig.7.2 shows the combined gravity and pumping system with hydraulic gradients during maximum and minimum demand.

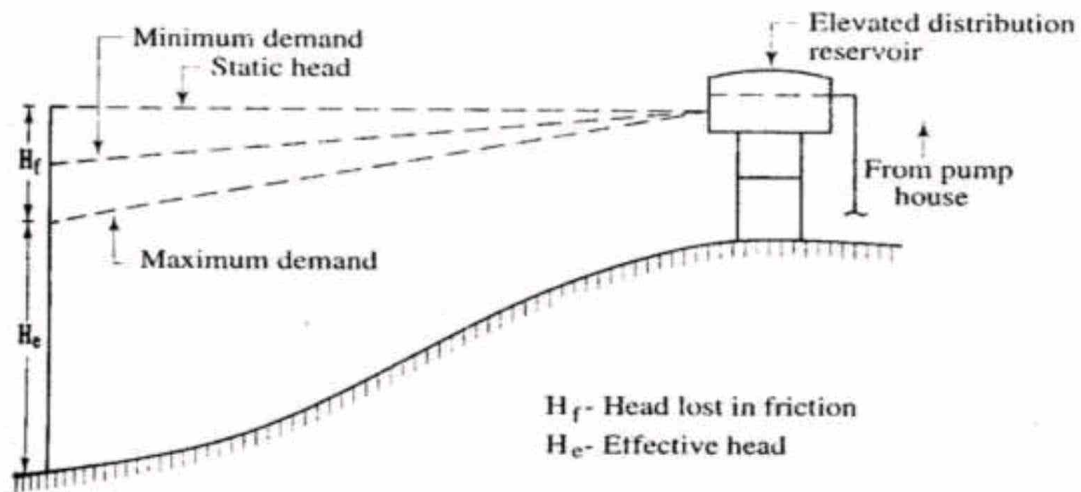

Combined gravity and pumping systems

Fig.7.2

This method of distribution is usually applicable in most of the cases and it has the following advantages:

- I. In case of a fire, the motor pumps can be used to develop high pressure or a fire demand can directly be satisfied from pump house after closing the inlet valve for elevated reservoir.
 - II. In this method the pumps are generally worked at uniform rate. Hence, they suffer less wear and tear.
3. **Pumping system:** - In this system, the water is directly pumped into the mains leading to the consumers. The number of pumps required in this system will depend on the demand of water. Fig. Shows the pumping system with hydraulic gradients during maximum and minimum demands.

SYSTEMS OF SUPPLY OF WATER: - Following are the two systems of supply of water which are based on the duration of supply.

- 1) **Continuous system:** - In this system of supply, the water is supplied to the consumers for 24 hours of day. This is the most ideal system of supply and it should be adopted as far as possible.

The only disadvantage of this system is that considerable wastage of water occurs, if consumers do not possess civic sense regarding the importance of treated water. One recommended way to avoid this defect of this system is to supply water through meters. Whether it is desirable to install meters or not is a debatable question and hence, the decision to install meters should be taken after careful considerations and deliberations.

2) **Intermittent system:** - In this system of supply the water is supplied during certain fixed hours of day only. The usual period is about one to four hours in the morning and about same period in the afternoon. For instance, the water may be supplied from 6.30 a.m. to 10.30 p.m. and from 5.30 p.m. to 8.30 p.m. The timing of supply of water may be changed to suit the seasons of year and it is more or less a matter of convenience only. This system of supply of water proves to be useful for the following two conditions:

- I. The available pressure is poor and
- II. The quantity of water available is not sufficient to meet with various demands for water.

Methods of layout of distribution of pipes:- Following are the four main methods of laying distribution pipes:

- 1) Dead end method
- 2) Grid iron method
- 3) Circular method
- 4) Radial method

1) **Dead-end method:** - This is also known as the free system of layout and it consists of one supply main from which sub-mains are taken. The sub-mains again divided into several branch lines from which service connections are given to the consumers.

Advantages: - Followings are the advantages of the dead-end method:

- I. It is possible to workout accurately the discharge and pressure at any point in the distribution system. The design calculations are simple and easy.
- II. The cut-off valves required in this system of layout are comparatively less in number.

Disadvantage: - Following is the disadvantage of dead-end method:

- I. During repairs the large portion of distribution area is affected. It results into great inconvenience to the consumers of that area.
- 2) **Grid-iron method:** - This is also known as the interlaced system or reticulation system. The mains, sub-mains and branches are interconnected with each other as shown in fig.7.3

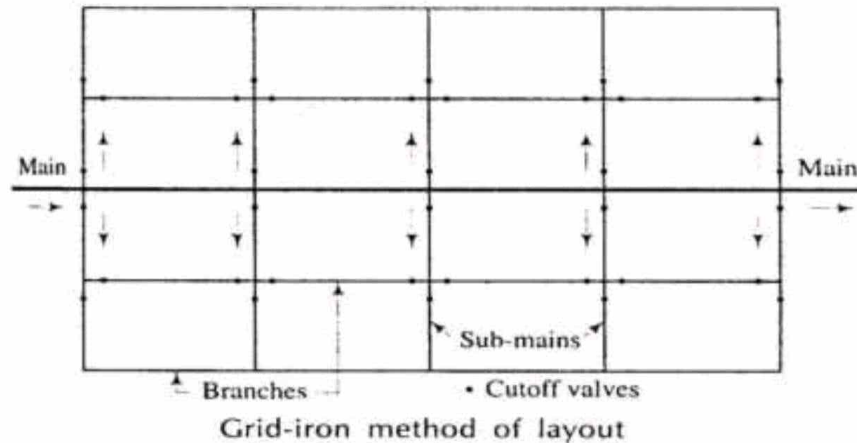

Fig.7.3

Advantages: - - Followings are the advantages of grid-iron method:

- i. In case of repairs a very small portion of the distribution area will be affected.
- ii. There is free circulation of water and hence, it is not liable for pollution due to stagnation.

Disadvantages: - Followings are the disadvantages of grid-iron method:

- i. The cost of laying water pipe is more.
- ii. The grid- iron system of layout requires longer lengths of pipes.

- 3) **Circular method:** - This is also known as the ring system and a ring of mains is formed around the distribution area as shown in fig.7.4. This system possesses advantages and disadvantages as those of grid-iron system.

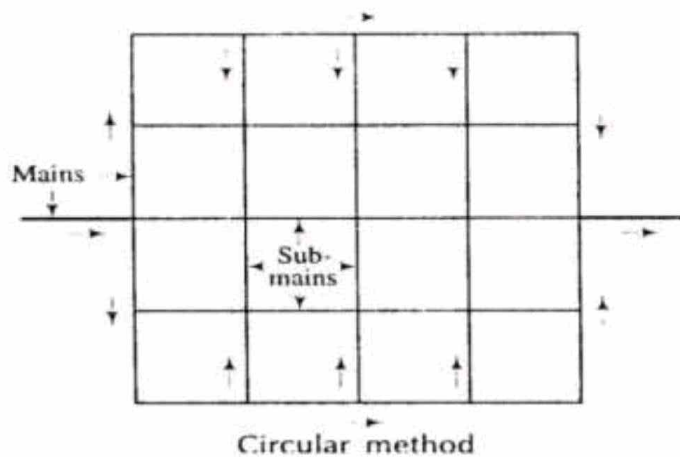

Fig.7.4

- 4) **Radial method:** - This method of layout is just the reverse of the ring method. In this system, the water is taken from the mains and pumped into the distribution reservoirs which are situated at centres of different zones as shown in fig.7.5. The water is then supplied through radially laid pipes. The radial method of layout gives quick service

and the calculations for design of sizes of pipes are simple. The radial method is most suitable for towns having roads laid out radially.

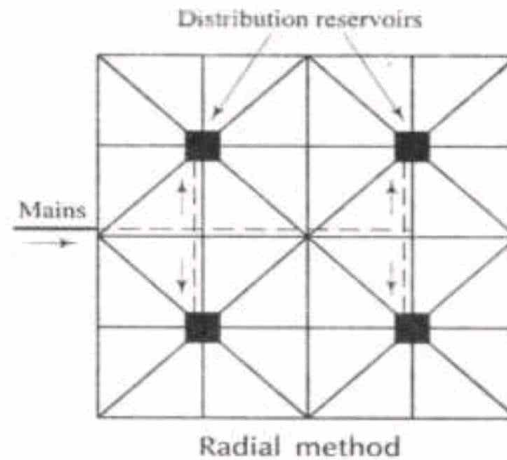

Fig.7.5

PRESSURE IN THE DISTRIBUTION SYSTEM

When the water enters in the distribution main, the water head continuously is lost due to friction in pipes, at entrance of reducers, due to valves, bends, meters etc. till it reaches the consumer's tap. The net available head at the consumer's tap is the head at the entrance of the water main minus all the losses in the way. The effective head available at the service connection to a building is very important, because the height up to which the water can rise in the building will depend on this available head only. The greater the head the more will be the height up to which it will rise. If adequate head is not available at the connection to the building, the water will not reach the upper storeys (i.e., 2nd, 3rd, 4th etc.). To overcome this difficulty the required effective head is maintained in the street pipe lines. The water should reach each and every consumer therefore it should reach on the uppermost storey. The pressure which is required to be maintained in the distribution system depends upon the following factors:

- (i) The height of highest building up to which water should reach without boosting.
- (ii) The distance to the locality from the distribution reservoir.
- (iii) The supply is to be metered or not. Higher pressure will be required to compensate for the high loss of head in meters.
- (iv) The supply is to be metered or not. Higher pressure will be required to compensate for the high loss of head in meters.
- (v) The funds available for the project work.

Appurtenance in distribution system:

Introduction:-

These days water treatment is essential for the safe and sound supply of water to manage the local requirements. When a mass of water is completely treated that after its needs to be distributed among the number of houses, Estates, industries and public places in a very planned way means this network is known as distribution system. This system is mainly enhanced by pipes of different sizes, valves, meters, pumps distribution reservoir, hydrant stand posts etc.

This system should provide the treated water with some degree of purity and should maintain required pressure head then it should be economical and reliable use. For efficient distribution it is required that water should reach or convey to every consumer with required rate of flow. So some pressure in the pipe is required which should force the water to convey at every demand. So considering the rate of flow pressure head in order to maintain a sound distribution system this system is classified as follows:-

- a. Gravity System.
- b. Pumping System.
- c. Combined Gravity System & Pumping System

[Description is not necessary according to the syllabus]

Some Important fitting Items.

In a network of distribution system a number of items are required but mainly Valves, Fire hydrants, and water meter plays a vital role in the distribution system and they are described as follows.

A. Valves:- Generally valves are needed to control the flow of water to regulate pressure to release or admit air to prevent flow of water in opposite direction. Valves are fitted according to the purpose of distribution. Some different types of valves are given below.

- a. Sluice valves
- b. Check Valves
- c. Air valves.

a. Sluice valves:-

These are also known as gate valves and are mostly used in water work. This is cheap and offer less resistance to flow of water. Gate valves control the flow of water through pipes and fixed in the main lines bringing water from the source to a town at 3 to 5 km interval.

As shown in fig.8.1

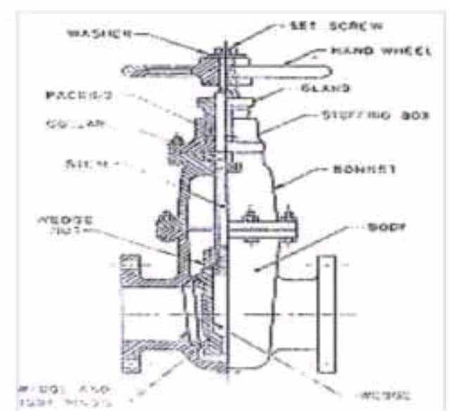

b. Check Valves:-

This is also known as return or non return valves. It automatically allows water to flow only in one direction and prevent it flowing in reverse direction. This type of valves has typical rises in one directional flow of water. As shown in fig.8.2

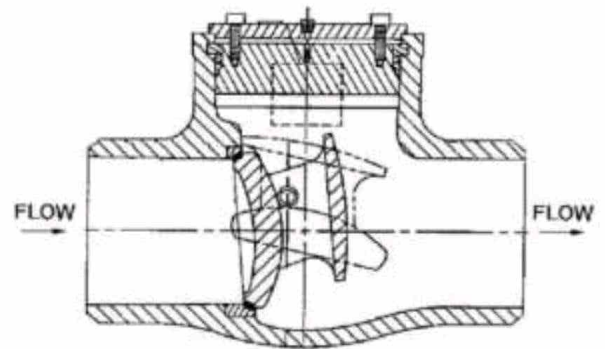

Fig.8.2

c. Air Valves:-

When water enters in pipe line some it also carries some air with it which tends to accumulate at high point of the pipe. When the quantity of air increases it causes seivour blockage to the flow of water therefore it is most essential to remove the accumulated air from the pipe line. Air valves are used for this purpose. As shown in fig.8.3

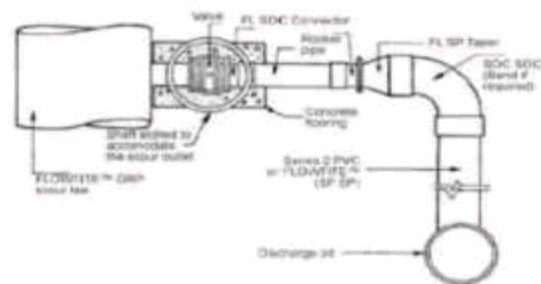

Fig.8.3

Fire Hydrants:-

This device are used for tapping water from mains for fire extinguisher, Street washing flushing swear line etc.. This are generally provided at all junction of road and at 100-130mt apart along road.

The hydrants are of two types.

- a. **Flush hydrants:-** This type of hydrants are installed in an underground bricks chamber flush with the footpath. It is covered from top by a C.I. cover. Some distinct sign is provided at it in order to locate the position of hydrant even at night. As shown in fig 8.4



Fig.8.4

Post hydrant:- This type of hydrants barrel is projected about 60-90cm above the ground surface. These hydrant have a long stem with screw and nut at the top to regulate the flow of water. The post hydrant is connected to the main pipes through a branch pipes and it is operated by means of a gate valve. as shown in fig 8.5



Fig 8.5

Water meters:-

This types of device are used to determine the quantity of water flowing through pipes. This are usually installed to measure the water amount supplied to provide house , industries public building etc. as shown in fig 8.6 Water meters are of two types:-

- a. The positive displacement type
- b. The velocity of inferential types.

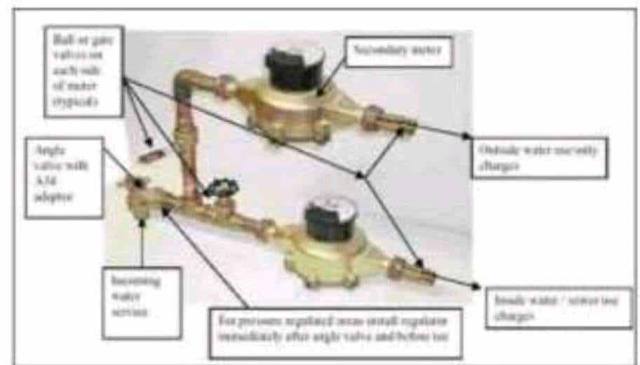

fig 8.6

Uses:-

- i. For the typical use of water meter the wastage of water is reduced.
- ii. It mostly used for private building, industries and other public sector.
- iii. It may be adopted by fire brigade.

W/S PLUMBING IN BUILDING

Method of water connection from water mains to building supply

The water receiving tank method, in which water is supplied via a water receiving tank, is generally used in apartment buildings and other high-rise structures, but there is also an approach known as the direct-connect method, in which water is supplied directly to faucets in the building without using a water receiving tank. This direct-connect method includes the direct-connect/direct-pressure method, in which water is supplied directly using only the water pressure in the water main, and the direct-connect/boost method, in which a boost pump is installed on the water pipe to bring the water pressure in the water main up to a sufficient level.

General layout of plumbing arrangement for water supply in multi-storied building

For plumbing purposes, the term “multi-storey” is applied to buildings that are too tall to be supplied throughout by the normal pressure in the public water mains. These buildings have particular needs in the design of their sanitary drainage and venting systems. Water main supply pressures of 8–12 metres (25–40 feet) can supply a typical two-storey building, but higher buildings may need pressure booster systems. In hilly areas, the drinking-water supply pressures will vary depending on the ground elevation. In these cases, the water authority may have to specify areas where particular supply pressures can be relied upon for the design and operation of buildings. Where a building of three or more storey's is proposed a certificate should be obtained from the drinking-water supply authority guaranteeing that the present and future public drinking-water supply pressure will be adequate to serve the building. If the public water pressure is inadequate, suitable means shall be provided within the building to boost the water pressure.

Water supply fittings-features, uses, purpose, fixing and jointing:-

PIPES AND PIPE FITTINGS

Various types of materials which are used in the construction of sewer pipes have been described in chapter 5. All those materials are also used in the construction of pipes required in house drainage. In house drainage works stoneware, asbestos cement, lead and iron pipes are used

For jointing, laying and fixing of soil waste, rain water and vent pipes of various types of fitting are required. as shown in fig 9.1

FIXING AND JOINTTING, PIPES AND ACCESSORIES

Rain water, soil waste and vent pipes can be embedded in the walls and floors or fixed on them. When they are embedded no fixing devices are required. But for ease in repairs and maintenance usually they are fixed on the outside of walls. For fixing those special types of brackets are required. fig shows one most common type of fixing bracket having aluminium painted clips. These brackets fit closely round the pipe or accessory directly beneath the socket and have ears for securing to the face of the face of the structure. When fixed, they present a neat appearance.

The jointing of pipes and accessories is done as follows. First a gasket or hemp yarn saturated with

Bitumastic jointing compound is caulked to about 2.5cm depth. Then the space between the collar and plain end is ground with stiff mortar of cement. Fig shows the method of jointing A.C. pipe

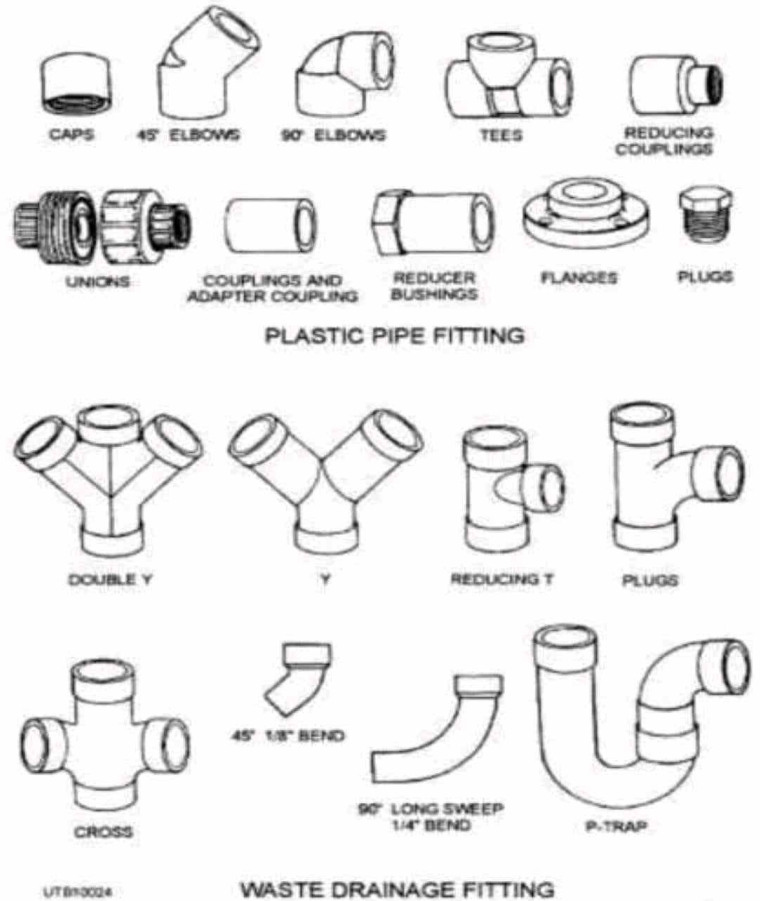
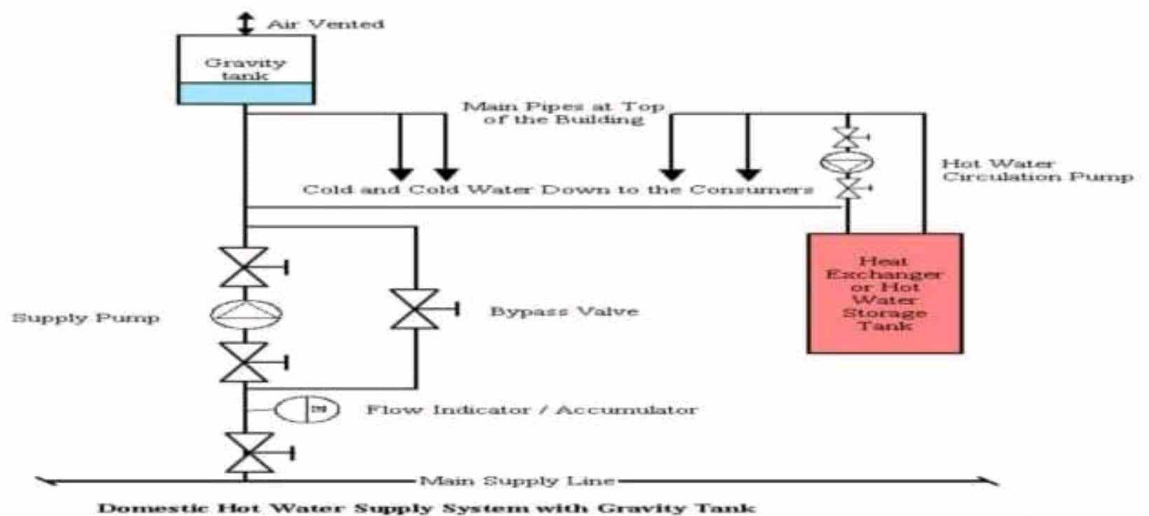

Fig 9.1

After fixing and jointing all pipes and accessories must be tested for water tightness. This is done by dividing the whole work in section and testing each section one by one.



HOT WATER SUPPLY:-

The water provided by hot water supplies in residential and public buildings and in industrial enterprises for their operational and daily needs must be potable and must satisfy the requirements of the All-Union State Standards. The quality of water intended for technical use is determined by the type of production service it will fulfill. Hot water supplies may be either centralized or local (decentralized). In centralized systems, the heat is generated by heat and electric power plants; and the so-called waste heat of industrial enterprises, underground sources, and other sources is also used. The heat is transmitted to consumers through heating system pipelines. The treatment of hot water is carried out at the heat sources themselves and at central heating points or right in the home. In local systems, the source of heat for warming the water is located at the place where the water is used. A centralized hot water supply may be a closed system in which the water is warmed by a heat-transfer medium (water or steam) from heating networks in water heaters that have been installed at central heating points or directly within the home. In hot water supplies built as open systems, the consumer obtains hot water directly from a heating network. This does away with the need to install water heaters in homes or at centralized heating points and lessens the possibility of corrosion in local pipelines. However, the maintenance of a demand level in such systems requires large volumes of water that have undergone preliminary treatment to prevent scaling and corrosion in the pipelines and the heat-transfer equipment. The maximum water temperature in hot water supplies is 75° C and the minimum (at water faucets) is 60° C.

To prevent cooling of the water in hot water supply delivery pipelines, a constant circulation is maintained during low-demand periods with the help of so-called circulation pipelines. In baths and showers there are heaters connected to the circulating system; with these the rooms are warmed and the towels are dried.

In order to even out the high- and low-demand loads and to cut the costs of heat sources, heat exchangers, heating networks, and water treatment, hot water accumulator tanks are used in centralized systems to store the hot water during low-demand periods, for its distribution during high-demand periods. All new residences and public buildings being constructed in the cities and industrial settlements of the USSR, as a rule, are provided with centralized hot water supplies. This also applies to all industrial enterprises.

In a local hot water supply system, the water heaters are installed right at the locations where the hot water will be used (baths, showers, washing machines, production equipment) and are heated by the burning of fuel (gaseous, liquid, or solid) or electric power. These devices usually require considerable expenditures of time and labor for servicing and, as a rule, do not operate continuously.

Electric water supply:-

The use of electricity for public and private supply of water and for wastewater treatment is an important factor in economic growth and sustainability in the United States. As the economy grows, all sectors increase their demand for fresh water and generate additional quantities of waste water that must be treated before discharge. This report estimates unit electricity requirements for the supply of fresh water and the treatment of wastewater across the U.S. economy. These unit electricity requirements are then used to project total electricity requirements for selected sectors of the economy. Sectors included in this analysis include:

- Public water supply agencies
- Publicly owned wastewater treatment facilities and privately operated wastewater treatment facilities
- Self-supply of water to the domestic, commercial, industrial, mining, irrigation, livestock, and thermal power generation sectors

The main question addressed by the study is: “Will there be sufficient electricity available to satisfy the country’s need for fresh water.” In order to make this assessment, unit electricity requirements for water supply and wastewater treatment were estimated. These were used in conjunction with projections of water consumption requirements for various economic sectors to develop aggregate electricity requirements for the period 2000 through 2020, with an extrapolation to the year 2050. Where possible, projections were carried out for each of the nine geographical areas defined by the U.S. Census Bureau.

The projections of electricity requirements for water delivery and wastewater treatment were also compared to a national forecast of electricity consumption by sector through the year 2020 to determine whether the estimates were reasonable. Further, issues and caveats regarding the forecast estimates were identified, and to the extent possible their impact on the estimates was qualified and quantified.

Solar water system:

We are blessed with Solar Energy in abundance at no cost. The solar radiation incident on the surface of the earth can be conveniently utilized for the benefit of human society. One of the popular devices that harness the solar energy is solar hot water system (SHWS).

A solar water heater consists of a collector to collect solar energy and an insulated storage tank to store hot water. The solar energy incident on the absorber panel coated with selected coating transfers the heat to the riser pipes underneath the absorber panel. The water passing through the risers get heated up and are delivered to the storage tank. The re-circulation of the same water through absorber panel in the collector raises the temperature to 80 C (Maximum) in a good sunny day. The total system with solar collector, storage tank and pipelines is called solar hot water system.

Broadly, the solar water heating systems are of two categories. They are : closed loop system and open loop system. In the first one, heat exchangers are installed to protect the system from hard water obtained from bore wells or from freezing temperatures in the cold regions.

In the other type, either thermosyphon or forced circulation system, the water in the system is open to the atmosphere at one point or other. The thermosyphon systems are simple and relatively inexpensive. They are suitable for domestic and small institutional systems, provided the water is treated and potable in quality. The forced circulation systems employ electrical pumps to circulate the water through collectors and storage tanks. The choice of system depends on heat requirement, weather conditions, heat transfer fluid quality, space availability, annual solar radiation, etc. The SHW systems are economical, pollution free and easy for operation in warm countries like ours. Based on the collector system, solar water heaters can be of two types. Flat Plate Collectors (FPC) based Solar Water Heaters The solar radiation is absorbed by Flat Plate Collectors which consist of an insulated outer metallic box covered on the top with glass sheet. Inside there are blackened metallic absorber (selectively coated) sheets with built in channels or riser tubes to carry water. The absorber absorbs the solar radiation and transfers the heat to the flowing water. There are 60 BIS approved manufacturers of Solar Flat Plate Collectors. Evacuated Tube Collectors (ETC) based Solar Water Heaters Evacuated Tube Collector is made of double layer borosilicate glass tubes evacuated for providing insulation. The outer wall of the inner tube is coated with selective absorbing material. This helps absorption of solar radiation and transfers the heat to the water which flows through the inner tube. There are 44 MNRE approved ETC based solar water heating suppliers. Solar water heating is now a mature technology. Wide spread utilization of solar

INTRODUCTION

Sanitation is a term which reseed to indicate the proper arrangement for the collection, treatment and disposal of air the waste water produced from different sources like bathroom, kitchen, lavatory, street wash etc and the science or technique that stands behind the sanitation is known as sanitary engineering. Proper sanitation is the most essential at every town or city even at every individual for a sound and safe community.

1- **Aims and Objectives :**

- The following are the basic aims and object of sanitary engineering.
- For the proper collection and disposal of wastes at every individuals house, public sector etc.
- To prevent the accumulation of disposed water.
- It also makes the final disposal at land or nearly water source after some primary treatment.

2- **Definition and terms related to sanitary engineering :****Anti-siphon age pipe:**

A pipe which is installed in the house drainage to preserve the water seal of traps is known as anti-siphon age pipe. It maintains the metallization and does not allow the siphonic action.

Siphon age:

Water seal of traps may break due to siphonic action and it is known as siphon age. It takes place when water is suddenly discharged from a filterer on ripper flower.

Vent Pipe:

The pipe which is reseed for the purpose of ventilation is known as vent pipe.

Refuse:

It is reseed to indicate what is left as worthless and for the study of sanitary engineering and it is divided in 5 categories.

- **Garbage :**
The dry refuse means decayed fruits, grass, leaves, paper pieces etc.
- **Sewage :**
It is the whole liquid waste generated from latrines, urinals, stables etc.
It is the combination of sanitary sewage and storm water.
- **Fresh Sewage :**
The sewage which has been recently organized or produced.
- **Septic Sewage :**
The sewage which is undergoing the treatment process.

Storm water:-it is used to indicate the rain water of the locality.

Sullage:- it indicate the waste water from bathrooms , kitchens etc.

Swear:-the underground conduits of the drains trough which the sewage is conveyed.

Sewerage:- The entire science of collection and carrying sewage by water carriage system through sewers.

System of collection of sanitation:-

For the disposal of waste water collection is the primary step and basically the sanitation of a town or city is done by following two methods. They are

- a. Conservancy system
- b. Water carriage system.

Conservancy System:-

It is actually a out of date system but in some small town , village or underdeveloped area this system is still present. These systems are also called dry system. In this system various types of refuse and storm water are collected converged and disposed by different method so it is called **conservancy system**.

Garbage or dry refuse are collected in the dustbins placed along the roads and streets from where it is conveyed by trucks to the point of disposal. All the non combustible portion of the garbage are reused for filling of lower level areas to re claim the lands for future use. The combustible portions of the garbage are burnt and the decaying fruits leaves and vegetables are first dried and then disposed of by burning or in the manufacture of manure.

Similarly, human excreta or night soil is collected separately by human agency and also all the liquid and semi- liquid waste. After removal of night soil they are brought into trenches which are outside of the town and get buried,. After 2-3 years they became very good manure.

In **conservancy system** the silage and storm water are carried separately in closed or open drums up to the point of disposal where they are allowed to mix up with streams, rivers or sea without any treatment.

Water Carriage System:-

With the development and advancement of cities urgent need was felt to replace the conservancy system with the some more improved type of system in which human agency should not be used for collection conveyance of sewage. After many experiments water is found as the cheapest substance for the collection and conveyance of sewage. As in the system water plays an important role. So it is called water carriage system. In this system all the refuse liquid and semi liquid waste are mix up with large amount of water and then they are taken out of the city with planned sewage system, where they can be disposed after necessary treatment in satisfactory manner.

Comparison between Conservancy System & Water Carriage System:

<u>Sl.no.</u>	<u>Conservancy System</u>	<u>Water Carriage System</u>
<u>1.</u>	Initial cost is low	Initial cost is very high
<u>2.</u>	Foul smell may found	There is no foul smell is occur
<u>3.</u>	Excreta is not removed immediately	Excreta is removed immediately with water.
<u>4.</u>	Storm water is carried in ritually surface drains hence no problem of pumping the storm water.	Sewage is treated before disposing off. It may or may not require pumping . It depends upon the topography of the town.
<u>5.</u>	This system is fully dependent upon human agency	No human agency is require for this system.
<u>6.</u>	In this system the sewage is disposed without any treatment. So it may pollute the water course or disposed area.	In this system sewage is treated upto required degree of sanitation

Introduction:

The sewage collected from the municipal area consists of wastewater generated from the residence, commercial centers, recreational activities, institutions and industrial wastewaters discharge into sewer network from permissible industries located within the city limits.

- Before designing the sewer, it is necessary to know the discharge i.e., quantity of sewage, which will flow in it after completion of the project.
- Accurate estimation of sewer discharge is necessary for hydraulic design of the sewers.
- Similarly, very high discharge estimated will lead to larger sewer size affecting economy of the sewerage scheme, & the lower discharge actually flowing in the sewer may not meet the criteria of the self-clearing velocity and hence leading to deposition in the sewers.

Sources of sanitary sewage:

- Water supplied by water authority for domestic usage, after desired use it is discharged in to sewers as sewage.
- The water drawn for various purposes by industries, from individual water sources such as wells, tube wells, lake, river, etc. Fraction of this water converted into waste water in different industrial processes or used for public utilities within the industry generating waste water. This is discharged into sewers.
- Infiltration of ground water into sewers through leaky joints.
- Entrance of rainwater in sewers during rainy season through faulty joints or cracks in sewers.

Quantity of sewage:

The sewage consists of the following two categories;

- I. Dry weather flow
- II. Wet weather flow

I. Dry weather flow;

It is defined as the flow of domestic sewage or sanitary sewage and industrial sewage.

- Compounds of DWF are;
 - a. Domestic sewage
 - b. Industrial sewage
 - c. Ground water infiltration

a. Domestic sewage:

Domestic sewage includes water and human excretions or other waterborne wastes that are incidental to the occupancy of a residential or non-residential building, but does not include manufacturing process water, wastewater from water softening equipment, commercial laundry wastewater cooling water, blowdown from heating or cooling equipment, water from cellar or floor drains, or surface water from roofs, paved surface.

- Domestic sewage is often used water from homes and apartments, primarily from the kitchen, bathroom, laundry. Dishwashing, garbage disposal and of course baths and showers are all part of the mix.

b. Industrial sewage:

Industrial sewage is defined as a mix of liquid and water borne wastes discharged from any industrial unit and resulting from any trade or process carried out in that unit.

- This includes waste from pre treatment facilities as well as polluted cooling water.

- It includes all trade waste generated by industrial plants or factories but excludes sanitary sewage from residence or hotels, restaurants, premises engaged solely in the sale, storage or repair of goods, wares, eating establishments, business merchandise in the industrial plants or factories.

c. Groundwater infiltration:

Infiltration in groundwater, or ground water that is influenced by surface or sea water that enters sewer pipes or side through holes, breaks joints failures, connection failures and other openings.

- Infiltration quantities often exhibit seasonal variation in response to groundwater levels.
- Since infiltration is related to the total amount of piping in the ground and not to any specified water use components, it is usually expressed either in terms of the total land area being served or in terms of the lengths and diameters of sewer pipe.
- The unit quantity used is gallons per acre per day(GPAD).

Factors influencing the estimation of DWF:

The various factors affecting the estimation of DWF are;

1. Rate of water supply
2. Population
3. Type of area
4. Infiltration of ground water into sewers
5. Exfiltration of sewage from sewers

1. Rate of water supply:

The sewers should be designed for a minimum of 150 lit/capita/day.

- Generally, 80% of the water supply may be expected to reach the sewers.
- When the industrial waste is fairly large, it is segregated and disposed off in suitable manner.

2. Population:

The quantity of sewage increases with respect to increase of population.

- For any water supply projects and waste water system the future population after three or four decades is determined by any suitable method of population forecast.

3. Infiltration:

It is leakage of water from the surrounding ground into the sewer.

- The infiltration depends on, Length of sewer, Size of sewer, Sub soil water head, Nature and type of soil.

4. Exfiltration:

It is the leakage of sewage from the sewer into the ground surrounding the sewer.

- Both infiltration and exfiltration are undesirable. The infiltration increases the quantity of sewage The exfiltration pollutes the underground sources of water.

Net quantity of sewage:

The net quantity of sewage production can be estimated by considering the addition and subtraction over the accounted quantity of water supplied by water authority;

Net quantity of sewage = Accounted quantity of water supplied from the water works +
 Addition due to unaccounted private water supplies +
 Addition due to infiltration -
 Subtraction due to water losses -
 Subtraction due to water not entering the sewerage system

- Generally, 70 to 80 % of accounted water supplied is considered as quantity of sewage produced.

Variation in sewage flow:

- Variation occurs in the flow of sewage over annual average daily flow. Fluctuation in flow occurs from hour to hour and from season to season.
- If the flow is gauged near its origin, the peak flow will be quite pronounced. The peak will defer if the sewage has to travel long distance.
- This is because of the time required in collecting sufficient quantity of sewage required to fill the sewers and time required in travelling.
- As sewage flow in sewer lines, more and more sewage is mixed in it due to continuous increase in the area being served by the sewer line.
- The magnitude of variation in the sewage quantity varies from place to place and it is very difficult to predict.

Computation of size of sewer:

- The designed velocity must be above the self-cleaning velocity and below the non-souring velocity.
- Use required formula like chezy's formula, Mannings formula to find out the velocity of flow.
- The minimum velocity and maximum velocity should be of 0.6 m/s and 3.0 m/s respectively.
- Gradient can be made flatter with the increase in diameter.
- No pipe should be laid at a gradient steeper than 1 in 20.
- House connections are laid usually at 1 in 40 to 1 in 80.
- Main pipes are laid at a minimum gradient of 1 in 100.

Application of Chezy's formula:

Chezy's formula;

$$V = C\sqrt{mi}$$

Where, m= Hydraulic mean depth

i= Slope at which the sewer is laid

C= Chezy's constant

Chezy's constant by Kutters formula,

$$C = \frac{23 + \frac{0.00155}{i} + \frac{1}{N}}{1 + \left(23 + \frac{0.00155}{i}\right) \frac{N}{\sqrt{m}}}$$

Where, N= coefficient of rugosity

m= Hydraulic mean depth=A/P

Chezys constant by Bazin's formula,

$$C = \frac{157.6}{1.81 + \frac{k}{\sqrt{m}}}$$

Where, k= Bazin's constant

Mannings formula,

$$V = \frac{1}{N} m^{\frac{2}{3}} i^{\frac{1}{2}}$$

Limiting velocities of flow: Self-cleaning and scouring:

A minimum velocity is to be maintained for the flow of sewage in the sewers, in order to prevent the settling of solid particles of the sewage, at the bottom and sides of the sewers is called Self cleaning velocity.

- The sewage flowing through a sewer contains organic as well as inorganic solid matter which remains suspended as the sewage flow.
- In order to keep the solid matter in suspended form, a certain minimum velocity of flow is required, otherwise the solid particles will settle in the sewer, resulting in its clogging. Such a minimum velocity is known as self-cleaning velocity.
- A minimum velocity of 0.6 m/s should be maintained in the case of separate sewers.
- A minimum velocity of 0.75 m/s should be maintained in the case of combined sewers.

Non scouring velocity:

It is defined as the maximum velocity permitted in a sewer to prevent scouring of pipe material.

- Non scouring velocity is limited to 3 m/s and preferably it should not exceed 2.25 m/sec.

General importance and strength of sewage:

- Sewage is dilute mixture of the various types of wastes from the residential, public and industrial places.
- The characteristics and composition of sewage mainly depends on this source.
- Sewage contains organic and inorganic matters which may be in dissolved, suspended, colloidal state.
- Strength of sewage refers to its capacity of producing nuisance to the public life and health.
- The nuisance is caused by the oxidizable organic matter present in the sewage.
- Organic matter in the sewage is unstable, thereby it undergoes decomposition in the periods of time.
- Strength of sewage is expressed in terms of Biochemical Oxygen Demand.
- Strength of sewage also depends on the offensive odour it will produce.
- Strength of sewage is indicated by following characteristics;
 - i. Total volatile solids both suspended and dissolved
 - ii. Odour
 - iii. Biochemical oxygen demand (BOD)
 - iv. Dissolved oxygen (DO)
 - v. Chlorine Demand
 - vi. Chemical oxygen demand(COD)

Characteristics of sewage :

The characteristics/ properties of waste water can be classified as,

- a. Physical characteristics
- b. Chemical characteristics
- c. Biological/ Bacteriological characteristics

a. Physical characteristics:

The most important physical characteristics are;

- i. Odour:
 - Normal fresh sewage has no smell. In 3-4 hrs, it loses all its oxygen and becomes stale.
 - Due to this the elimination of odours has become a major consideration.
- ii. Colour:
 - Fresh sewage is yellow in colour. Sometimes grey or light brown also indicates the fresh sewage.
 - If the sewage colour is black or dark, it indicates decomposed or stale sewage.
 - Other colours are formed due to the presence of some chemicals from industries.
 - Colours should be less than 15 TCU (True Colour Units)
- iii. Temperature:
 - Temperature variation caused the biological activity of sewage, solubility of gases and viscosity of sewage.
 - If temperature increases, the viscosity of sewer decreases.
 - The reduction in viscosity causes increase in efficiency of treatment units.

iv. Turbidity:

- The sewage is generally turbid and it is caused by the presence of floating and suspended matter.
- The turbidity of sewage can be calculated as same in the case of water.
- Turbidity measured in terms of NTU(Nephelometric Turbidity Units), JTU(Jackson Turbidity Units) and FTU.
- NTU is the standard measure.

b. Chemical characteristics:

i. Solids:

- Total solids in waste water exist in four different forms;
Suspended solids, Colloidal solids, Dissolved solids, Settleable solids
- Suspended solids refer to matter floating on the liquid or remaining in a state of suspension.
- This will be about 0.0112% by weight of sewage.
- Colloidal solids are very finely divided solids remaining in suspension and which do settle down with out the help of coagulant.
- Dissolved solids are about 0.0225% by weight of sewage.
- These are solids which are dissolved in the solution.
- The solids present in the sewage may be of both organic and inorganic matter.
- Organic matter is present to the extent of 45% by weight of total solids.

ii. Other chemical substances:

- Sewage may contain surfactants, fats, oils, greases, etc.
- Fats and oils are mainly contributed from kitchen wastes and they contains the compounds like alcohol and glycerol with fatty acids.
- Fats are among the more stable of organic compounds and are not easily decomposed by bacteria.
- This matters are float on the top of sedimentation tanks, often choke pipes in the winter and clog filters.
- They thus interfere with functioning of normal treatment plants and cause maintenance problems.
- Sewage may also contains chlorides, compounds of nitrogen, phosphorus, Sulphur, toxic compounds and heavy metals.

iii. Gases:

- Some commonly found gases in untreated waste water are;
Nitrogen(N_2), Oxygen(O_2),Carbon dioxide(CO_2),Hydrogen sulphide(H_2S),Ammonia(NH_3),Methane (CH_4)
- Methene gas is the principal by product of the anaerobic decomposition of the organic matter in waste water.
- This gas is colourless, odourless and highly combustible.
- Since its explosion hazard is high, manholes, sewer junctions, junction chambers etc., should be kept well ventilated.

c. Biological characteristics:

- Domestic sewage by its nature ,contains enormous quantities of micro organisms.
- The biological characteristics of sewage mainly related to the presence of these micro organism.
- Micro organisms include viruses, bacteria, Algae,fungi,protozoa,etc.
- Bacteria are present very large number in sewage.
- Majority of them are harmless.
- They play big part in the purification of sewage.
- According to oxygen demand, bacteria can be classified as;
 - Aerobic bacteria which needs oxygen to live.
 - Anaerobic bacteria which survives in the absence of oxygen.
 - Facultative bacteria which can live and multiply with or without oxygen.

Sampling of sewage:

- The physical and chemical characteristics of sewage vary from top to bottom of sewage depth.
- So it is necessary that the sample collected for analysis should be fairly representative of the sewage.
- Hence samples are collected at various depths and at frequent intervals of time.
- Most sampling requirements for waste water analysis can be fulfilled by manual sampling using simple field equipment including buckets,funnels and suitable lengths of chain or dip poles.
- These sampling may be done by 2 methods, Grab samples & composite samples.

a. Grab samples:

- In sampling, catch sample collected from the sampling spot at any instant, to determine the character of the sample at that particular instant is known as grab sample.
- Grab samples should be collected by dipping an appropriate container, bucket, bottle or vial into the waste water stream using an appropriate retrieval device, such as a chain or pole.
- Grab samples may be taken from a slipstream and valve after purging the sample line, the samples should be collected into appropriate laboratory containers.
- Grab sampling may also be conducted using an automated sampler in manual mode when the automatic function fails.
- If necessary, a pump may be used to draw the sample.

b. Composite method:

- Composite sample is a mixture of different grab samples collected at the same sampling point at different times.
- Composite sample can be collected either by automated or manual methods.
- A manual composite sample consists of grab samples typically taken at equally spaced time intervals and combined once all sub samples have been collected.
- Automated composite samples can be taken either proportional to the waste water stream flow or on equal volume/equal time basis.
- Both of these approaches require fully automated, programmable sampling devices.
- To keep the sample cool and to prevent the biological action taking place in the sewage sample, preservations such as chloroform, formaldehyde and sulphuric acid are added in the sample.
- This samples are kept at a temperature of less than 10°C.
- The characteristics of preservative should not affect the results of the analysis to be made.
- A composite sample representing a 24 hrs. period is considered as standard for most determinations.

Solids:

Total solids;

- ➔ In this test, the suspended, dissolved and colloidal solids are determined separately and then added together to get total solids.
- ➔ The amount of total solids should preferably be less than 500 ppm, maximum permissible limit is 2000 ppm.
- ➔ In order to determine the suspended solids, water is filtered through fine filter paper. The material retained on the filter is dried and weighed.
- ➔ In order to determine dissolved and colloidal solids the sample of water is heated and the dry residue left is weighed.

pH:

- ➔ pH of sewage is defined as the negative log of hydrogen ion concentration present in sewage.
- ➔ pH is an indicator of the alkalinity of sewage.
- ➔ The determination of pH value is important, because the efficiency of some treatment depends on the pH of the sewage of the sewage.
- ➔ The fresh sewage is alkaline in nature. After the bacterial action, the pH value of sewage get reduced i.e. pH value <7.
- ➔ pH value is measured by potentiometer know as pH meter.

Dissolved oxygen:

- ➔ The dissolved oxygen analysis measure the amount of gaseous oxygen dissolved in water or wastewater. Oxygen is a necessary element in all forms of life.
- ➔ Oxygen dissolved in waste water encourages the growth of aerobic bacteria. Adequate dissolved oxygen is needed to allow natural stream purification process to proceed and provide for aerobic life forms in the receiving water.
- ➔ There are several laboratory methods to determine dissolved oxygen content. The most commonly used analysis is a wet chemistry method referred to as the Winkler method.

Biochemical Oxygen Demand(BOD):

- The BOD is a measure of the oxygen required to oxidize the organic matter present in a sample, through the action of micro organisms contained in a sample of waste water.
- The BOD may be defined as the oxygen required for the micro-organisms to carry out biological decomposition of dissolved solids or organic matter in the water under aerobic conditions at standard temperature.
- The BOD test results are used for following purposes;
 - i. Determination of approximate quantity of oxygen required for the biological stabilization of organic matter present in the waste water.
 - ii. Determination of size of waste water treatment facilities.
 - iii. Measurement of efficiency of some treatment processes
 - iv. Determination of strength of sewage.
 - v. Determination of amount of clear water required for the efficient disposal of waste water by dilution.
- Generally a 5 day period is chosen for standard BOD test, during which oxidation is about 60 to 70 % completed, while within 20 days period, the oxidation is about 95 to 99 % complete.
- A constant temperature of 20°C is maintained during the incubation.
- The BOD value of 5 day incubation period is commonly written as BOD₅ or 5 day BOD.

Chemical Oxygen Demand(COD):

- Organic matter is most often assessed in terms of oxygen required to completely oxidize the organic matter to CO₂,H₂O and other oxidized species.
- Hence, If the organic compounds and their concentrations are known, the theoretical oxygen demand of the water can be accurately calculated.
- But it is virtually impossible to know the details of the organic compounds present in any type of waste water.
- The COD of a waste water is therefore determined by performing a laboratory test on the given water with a strong oxidant like dichromate solution.
- The theoretical computations of COD are only performed on water solutions prepared with the known amounts of specific organic compounds.

System of sewerage:

Following are the three system of sewerage

- Separate system
- Combined system
- Partially separate system

Separate system:-

In this system, the two sets of sewers are laid- one for carrying sewage and the other for carrying storm water. The sewage is carried to the treatment plant and the storm water is directly discharged into the natural outlet in the form of river or stream.

Advantages:-

1. The load on treatment unit becomes less.
2. The sewers are small in size.
3. The storm water can be discharged into natural streams without any treatment.
4. The natural water is not unnecessarily polluted as the storm water is not foul in nature.

Disadvantages:-

1. The cleaning of sewer is difficult as they are of small size.
2. The system requires two sets of sewer and hence it may prove to be costly.
3. The sewer line carrying the storm water remains idle in dry period. So it may be clogged by garbage in that period.

Combined system:-

In this system, only one set of sewer is laid and it carries both, namely, sewage and storm water. The sewage and storm water are carried to the sewage treatment plant.

Advantages:-

1. It is easy to clean a combined sewer as it is of large size.
2. The storm water reduces the strength of sewage by dilution.
3. This system requires only one set of sewer and it may thus prove to be economical.

Disadvantages:-

1. During extraordinary heavy storms, the combined sewer may overflow and it may thus put public health in danger.
2. The combined sewer, if not properly designed, gets easily silted.
3. The sewers are large in diameter.
4. The treatment plant is unnecessarily loaded with the combined volume of sewage and storm water .it may exceed the normal capacity of the plant.

Partially separate system:-

This system consists of two sewer lines, one is of large diameter for carrying sewage and the other is of smaller diameter for carrying storm water only. When it rains, the storm water, at the beginning is allowed to flow with the sewage through the large sewer line. When the rain continues for a long time then the excess storm water is diverted to the smaller sewer line to discharge in the river directly. Thus the load on the treatment plant is controlled and kept within the permissible capacity of the plant.

Advantages:-

1. The entry of storm water avoiding silting in sewers.
2. The sewers are of reasonable size.
3. It reduces the load on the treatment plant and the excess storm water may be safely discharged in the river.
4. The storm water from individual houses may be safely disposed of to the large sewer.

Disadvantages:-

1. The smaller sewer remains idle in dry season.
2. If the division of storm water is not done at proper time, then it may create unnecessary trouble both in the treatment plant and in the streets.

Shapes of sewer:

Generally, the circular shaped sewers are adopted. The advantages of circular sewer are:

1. The perimeter of circular sewer is the least with respect to the sewer of other shape.
2. The inner surface is smooth hence the flow of sewage is uniform and there is no chance of deposition of suspended particle.
3. The circular sewer is easy to construct.

The following are the non circular sewers that are commonly adopted:

(1) Basket-Handle section:

In this sewer, the outer surface is circular. The inner surface is divided into two portions.

As shown in figure 12.1, the upper portion resembles a basket handle and the lower portion is like a channel. During dry season the sewage flows through the lower portion and during monsoon the combined sewage flows through the full section.

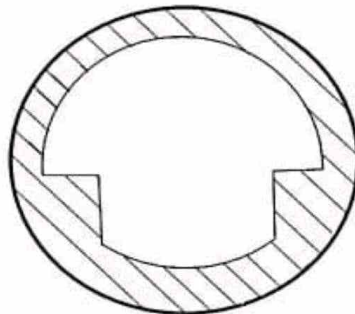

Figure 12.1

(2) Egg-shaped section:

The egg-shaped section sewers may be of two types such as normal egg shaped and inverted egg shaped. Both the sections are suitable for carrying D.W.F and combined sewage.

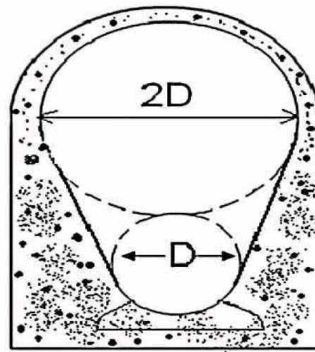

Figure 12.2

(3) Horse shoe section:

This type of sewer is constructed for carrying heavy discharge. This is like a tunnel and resembles a horse-shoe, as shown in figure 12.3. The size is so large that the maintenance works within the sewer are very easy.

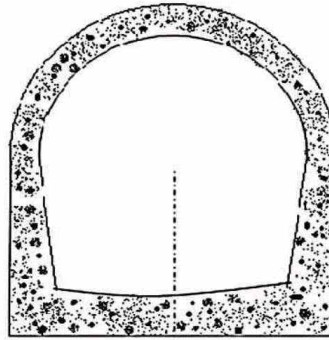

Figure 12.3

(4) Parabolic section:

As shown in figure 12.4 the upper surface of the sewer is in the shape of a parabola and the invert is in the shape of an ellipse. This type of sewer is suitable for carrying small discharge.

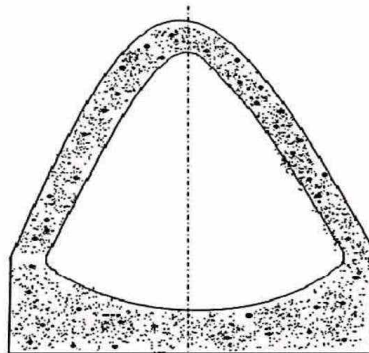

Figure 12.4

(5) Rectangular section:

This type of sewer can be easily constructed. These are suitable for large sewers to carry heavy discharge of sewage. The maintenance works are easy in this section.

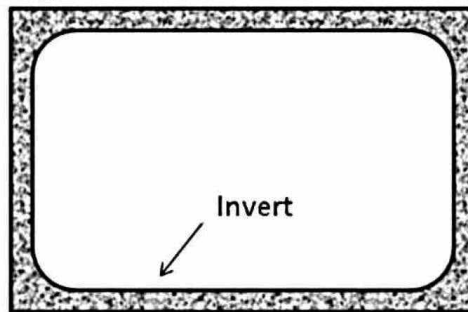

Figure 12.5

(6) U-shaped section:

As shown in figure 12.6 this type of sewer resembles the letter “U”. This type of sewer is suitable for carrying heavy discharge. The maintenance works are easy in this section.

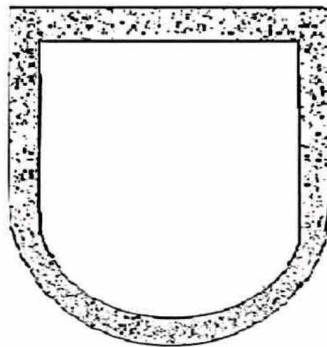

Figure 12.6

Comparison of system of sewerage ;

Sl no	Item	Separate System	Combined system	Partially separate system
1	Number of sewers	Two sets	One set	Two sets
2	Arrangement of sewers	Difficult	Simple	Difficult
3	Size of sewers	Small	Large	Medium
4	Load on treatment	Less	More	Medium
5	Cleaning	Difficult, flushing is necessary	Easy No flushing required	Difficult Flushing is less
6	Maintenance	High	Low	Reasonable
7	Operation	Difficult	Easy	Difficult

Types of sewers;

1. Sewer;

Sewer is an underground conduit or drain through which sewage is conveyed to the point of discharge or disposal.

2. Sewerage system;

A sewerage system consists of a network of sewers, for carrying the sewage from individual units (homes and industries) to the sewage treatment plants.

3. Main sewer;

Main sewer or trunk sewer is a sewer that receives sewage from many tributary branches and sewers, serving as an outlet for a large territory.

4. Branch sewer;

Sewer which receives sewage from a relatively small area, usually a few laterals and discharge into a main sewer.

5. Lateral sewer;

Sewer which collects sewage directly from the houses. It indicates the first stage of sewage collection.

6. Separate sewers;

Sewer which carry the house hold and industrial wastes only.

7. Storm water drains;

Sewer which carry rain water from roofs and street surfaces.

8. Combined sewers;

It's a sewer which carry both sewage and storm water.

9. House sewer;

It is a pipe carrying away the sewage from a building to a street sewer.

10. Depressed sewer;

It is section of sewer constructed lower than adjacent sections, to pass beneath an obstacle or obstruction. It runs full under the force of gravity.

11. Intercepting sewer;

Sewer laid transversely to a general sewer system to intercept the dry weather flow (D.W.F.) of sewage and such additional surface and storm water as may be desirable. An intercepting sewer is usually a large sewer, flowing parallel to a natural drainage channel, into which a number of main or outfall sewers discharge.

12. Outfall sewer;

Sewers that receives sewage from the collecting systems and conducts it to a point of final discharge or to a disposal point.

13. Relief sewer or overflow sewer;

Sewer built to carry the flow in excess of the capacity of existing sewer.

Laying of sewer

(1) Making centre lines of sewers:-

- The centre lines of sewers are marked on the streets and roads from the plan starting from the lowest point or the outfall of the main proceeding upwards.
- The setting out of work is done by means of chain and theodolite and compass.
- For checking the centre line during construction generally wooden pegs are driven at 10 metres interval on a line parallel to the centre line at such a distance where while laying sewers, they will not disturb them.
- For checking the levels of the sewer pipe and their alignment temporary bench marks are established at 200-400 metre interval.
- On the centre line of sewers the positions of the sewer appurtenances are also marked as per the plan which have been finalised.

(2) Excavation of trenches:-

- As in most of the towns the need of sewerage occurs after the development of the town i.e. when its roads, streets are constructed, laying the sewer line is usually done along the sides of the streets or in its middle.
- Therefore after marking the layout of the sewer lines on the ground, the first step is the removal of pavement.
- The removal of the pavement is started from the lower end of the sewers and proceeds upward.
- After removing pavement the excavation of trench is started. The excavation of trenches is done manually in India where as in some countries it is done by means of machinery.
- The width of trench depends on the diameter of the sewer and the depth of sewer line below the ground level.
- For large size sewer the trench width should be 15 cm more than the external diameter of the sewer for easiness in lowering and adjusting the sewer pipe.
- The minimum trench width of 60 to 100 cm is necessary for conveniently laying and jointing of even very small size sewer.
- Sometimes in case of small diameter sewer, the trench width is kept about 15 cm larger than the sewer dia but at both the end bigger trench is excavated for jointing the pipes as shown in figure 12.7.

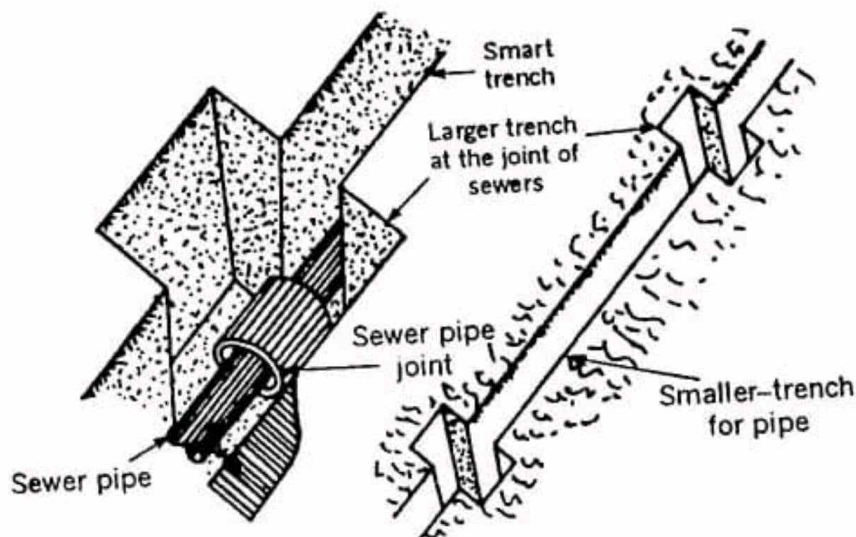

Excavation of trenches

- If the trench has been excavated within one half of the diameter of the sewer pipe from the bottom and in case the soil material is firm, the remaining trench should be excavated in semi circular shape, to conform to the shape of the lower half of the outer side of the pipe.

(3) Bracing and dewatering of trenches:-

- In case of hard soils and rocks, the sides of the excavated trench will not collapse and will remain in cut position. But in case of soft soil the trench sides require shoring and strutting to prevent their collapse till the sewer are laid and tested.
- The following are the function of the timbering or shoring:
 - (i) To prevent the collapse of the sides of the trenches.
 - (ii) To reduce the width of the trench at the top to the minimum possible.
 - (iii) To prevent the seepage of the ground water into the trench.
 - (iv)

Various methods of shoring and bracing of trenches have been shown in figure 12.8.

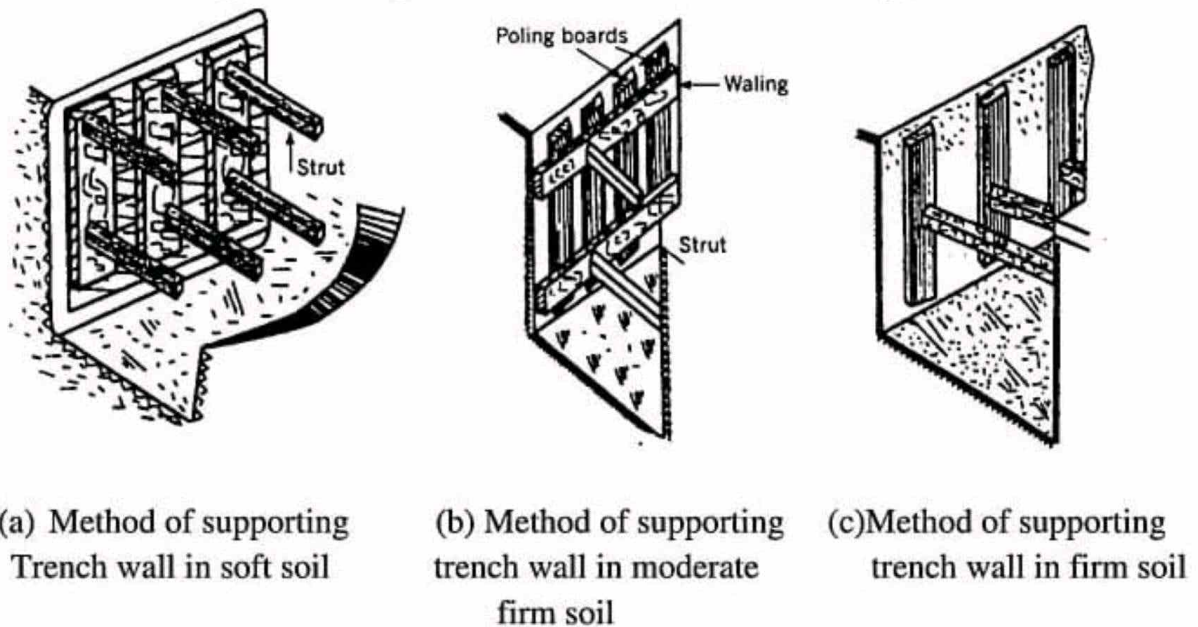

Figure 12.8

When sewer lines are to be laid below the ground water table, the ground water enters the trenches during excavation and causes many difficulties. Therefore the dewatering of trenches is compulsory under such circumstances. There are various methods for the removal of this water, but most common are:

- **Gravity method:-**

In this method the excavation is started from the lowest level and is done upwards so that whatever water enters the trench it automatically flows towards outlet due to gravity.

- **Pumping method:-**

In this method during excavation the amount of water entering the trench is pumped outside the trenches. In some cases the level of water table is depressed by driving driven wells along trenches and pumping the ground water.

At some places porous pipe is laid below the main sewer line to collect the ground water entering in the trench. This porous pipe carries the seepage water to the

water courses. At the sewer construction work is started from the lower level, the water entering the trench must be carried by the sewer constructed. But even if it is not possible to convey the seepage water through the sewer under construction, it may be pumped out.

(4) Laying of sewers:-

Trenches are excavated with proper grade so that the sewage may flow in sewers due to gravitational flow only.

Sewer pipes may have to be laid under the following conditions:

- (a) **Culvert condition:** When the pipe is laid under embankment and it projects wholly or partly above the original surface or sub grade.
- (b) **Trench Condition:** When the pipe is laid in a trench excavated for the purpose.
- (c) **Negative projecting condition:** when the pipe is laid in a relatively narrow and shallow trench in such a manner that the top of the pipe is at an elevation below the natural ground surface.
- (d) **Open Condition:** In this condition, the pipe is laid such that it projects wholly or partly above the ground surface.

When a sewer has to be laid in soft underground strata the trench shall be excavated deeper than what is ordinarily required. The trench bottom shall be stabilised by the addition of coarse gravel or rock. In case of very bad soil the trench bottom shall be filled in with cement concrete of appropriate grade.

The sewer pipes are not usually laid directly on the soil in the trenches. Before actual lying the bottom of the trench is prepared to receive the pipe such that the load is distributed uniformly. It is always preferred to provide concrete bedding in the trench below the sewer pipes. Figure 12.9 shows various types of pipe beddings usually provided under various conditions.

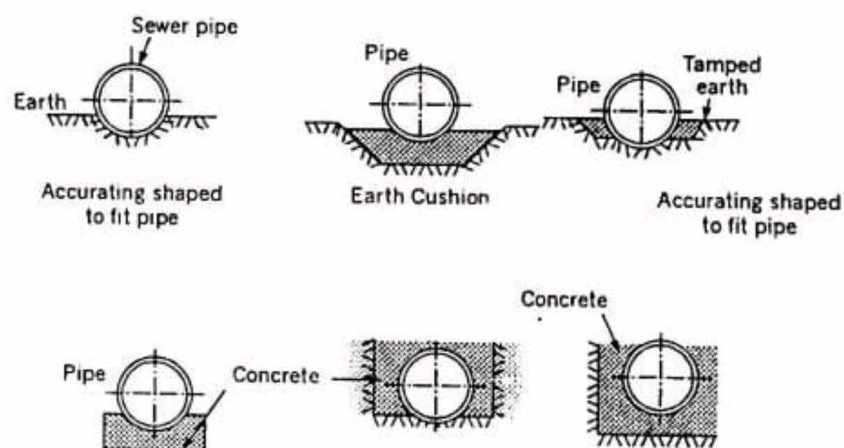

Various types of pipe bedding

Figure 12.9

The centre line of sewers and their grades are transferred from the ground by means of sight rail and boning rod as shown in figure 12.10 by the following method:

- (i) Four stout stakes are driven into the ground or fixed over the pillars.
- (ii) Horizontal boards called sight rail are fixed on the stakes spanning the trench.
- (iii) The centre line of sewer is marked on the sight rail and nails are fixed on the sight rails at the position of centre line.

- (iv) The top of the nail or sight rail is fixed at some fixed distance from the invert level of the sewer at that spot. The line joining the top of nails fixed on the sight rails also confirm to the grade of the sewer.
- (v) Sight rails are usually fixed at 7.5 m centre to centre spacing and also at all junctions and change of gradient or alignment.
- (vi) Now a strong wire is stretched between the nails fixed on sight rails. This line is parallel to the grade of the sewer and also lies in the vertical plane passing through the centre line of the sewer.
- (vii) Now with the help of boning rod using plumb bob the line and grade to the sewer line is given as shown in figure 12.10.

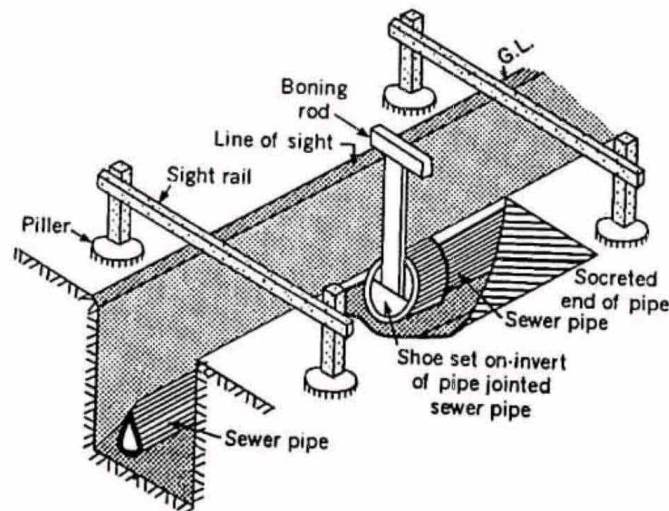

Laying of sewer pipe
Figure 12.10

Smaller size pipes can be laid by the pipe-layers directly by hand only, but heavier and larger size pipes are lowered in the trenches by passing ropes around them and supporting through a hook.

(5) Jointing of sewers:-

- (i) **Stoneware pipes:** - All the pipe joints shall be caulked with tarred gasket in one length for each joint and sufficiently long to entirely surround the spigot end of the pipe. This gasket shall be caulked lightly but not so as to occupy more than a quarter of the socket depth. The gasket shall then be filled with a mixture of one part of cement and one part of clean fine sand mixed with just sufficient quantity of water to have a consistency of semi-dry condition and a fillet shall be formed round the joint with a trowel forming an angle of 45° with the barrel of the pipe.
- (ii) **Concrete pipes:** - The collars shall be placed symmetrically over the end of two pipe and the annular space between the inside of the collar and the outside of the pipe shall be filled with cement slurry tamped with just sufficient quantity of water to have a consistency of semi-dry condition, well packed and thoroughly rammed with caulking tools and then filled with cement mortar 1:2. The joints shall be finished off with a fillet sloping at 45° to the surface of the pipe. The finished joints shall be protected and cured for at least 24 hours. Any plastic solution or cement mortar that may have squeezed in the pipe shall be removed to leave the inside of the pipe perfectly clean.

- (iii) **Cast Iron pipes:** - The C.I pipes shall be examined for line and level and the space left in the socket shall be filled in by pouring molten pig lead. This shall be done by using proper leading ring. One or two air vents shall be provided around the lower end of the joint. The lead used shall be soft and of best quality.

(6) Hydraulic testing of sewer pipes:

Following two tests are generally done for testing the sewer pipes:

- (i) **Water test:** - Each section of the sewer is tested for water tightness preferably between manholes. The sewers are tested after giving sufficient time for the joints to set for no leakage. For this sewer pipe sections are tested between the manholes to manhole under a test pressure of about 1.5 m water head. To carry this, the downstream end of the sewer is plugged and water is filled in the manhole at upper end. The depth of water in manhole is maintained at about 1.5 m. The sewer line is inspected and the joints which leak are repaired.
- (ii) **Test for straightness of alignment:** - This can be tested by placing a mirror at one end of the sewer line and a lamp at the other end. If the pipe line is straight, full circle of light will be observed.

(7) Backfilling of trenches:

- (a) After testing and removing defects of pipe line, the trenches are back filled with earth. Generally the excavated soil of trench is used for back-filling but before using it, the pebbles, stone pieces and lumps must be removed from it.
- (b) The back filling is not done at a time. First the back filling is done by ramming the soil in layers, using water for proper consolidation. When the height of the back filled rammed soil reaches 60 cm above the crown of the pipe, the back-filling is stopped for at least one week for weathering.
- (c) After a week, again the back filling is started in layers and the trench is filled 15 cm above the ground level. During the course of time back-filled soil gets compacted and the filled soil comes to the ground level.
- (d) The back-filling is not done immediately after construction of the sewer lines. It is done after 7 days for precast pipes and after 14 days in case of cast-in-situ after casting the sewer. Tamping should be done carefully when doing it near the crown of the sewer.

(8) Ventilation of sewers: -

The sewers are to be properly and satisfactorily ventilated for the following two reasons:

- (i) **Continuous flow:** The surface of sewage should remain in contact with free air; otherwise air-lock will be formed.
- (ii) **Disposal of sewer gases:** The decomposition of sewage inside the sewers develops gases which are known as the sewer gases. These gases are harmful in many ways and hence they should be carefully disposed off in the atmosphere.

The sewer gases include ammonia, carbon monoxide, carbon dioxide, methane, nitrogen etc. The gases like methane are highly explosive and if sewer is not properly ventilated, the manhole covers may be blown off. Similarly the gases being light in weight have a tendency to move upwards. They also interfere with the natural flow of sewage and cause air pollution when they escape into atmosphere.

Methods of ventilation: Following six methods are adopted for the ventilation of sewer:

- (a) **Manholes with chemicals:** - In this method, the chemicals are placed in the manhole covers. These chemicals react with the sewer gases and make them harmless. As this method is costly, it is rarely adopted.
- (b) **Manholes with gratings:** - In this method manhole covers are provided with gratings or openings through which sewer gases escape. This is a simple method. But it causes air pollution and hence it is adopted for isolated places where air pollution does not cause public nuisance. The other disadvantage of this method is that it permits road dust, storm water etc. to enter the sewer.
- (c) **Proper construction of sewers:** - The sewer should be laid at such a gradient that self cleansing velocity is developed and the sewage will have no chance of staying at one point for a longer period.
- (d) **Proper design of sewer:** - The sewers are designed to run two-third or even one half full and the remaining top space is reserved for the accumulation of sewer gases. The proper design of sewer ensures enough ventilation of sewers.
- (e) **Proper house drainage system:** - the lateral sewers are ventilated independently by suitable provision of ventilating shafts or columns. The sewer gases are carried in these columns and they are relieved in atmosphere above the height of the building.
- (f) **Ventilating columns or shafts:** - the ventilating columns or shafts are formed by joining cast-iron or steel pipes. They are placed at a distance of about 60 m or 150 m along the sewer line. A foundation block is provided at the bottom end of shaft to keep it in vertical position. A cowl is provided at the top end of shaft to allow the escape of sewer gases.

Figure shows a typical vertical column used for the ventilation of sewer.

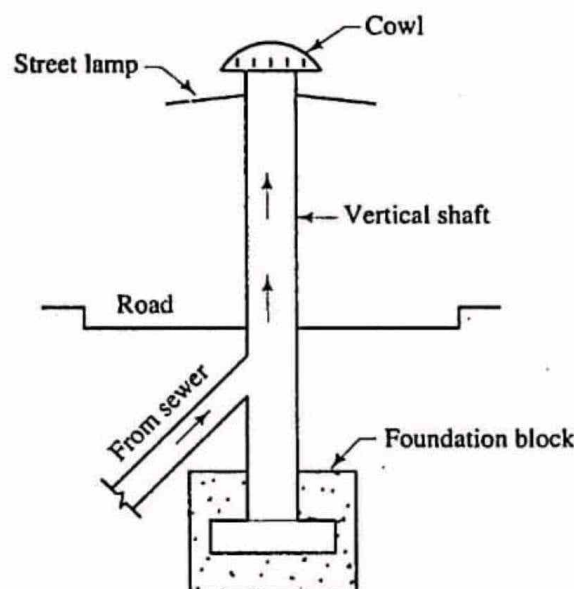

Ventilating Column

Following points should be kept in mind when this method of ventilation of sewers is adopted:

- (i) The internal diameter of the ventilating column should be preferably one- third of the diameter of the sewer which is being served by it.
- (ii) The joints of pipes forming the ventilating column should be made airtight. If the joints are not airtight, there will be leakage of sewer gases and it will result in unpleasant odours causing nuisance in the surrounding area.
- (iii) The location of ventilating columns should be such that they obtain sunshine for the major portion of the day. The heat of sunshine causes proper circulation of air.
- (iv) The top of ventilating column should be covered with wire mesh or cowl so as to prevent the birds from building their nests at the top of ventilating columns.
- (v) The ventilating columns should be carried higher than the height of nearby structures.

(9) Cleaning and maintenance of sewers:

The sewers should be properly cleaned and maintained in good working condition. The sewers which are once laid and buried into the ground should not be forgotten as they are also liable to corrosion, deterioration and erosion etc.

Causes: There are three important causes which make it necessary to clean the sewers

- (i) **Breakage of sewers:** - The sewers are sometimes broken after being laid under the ground. Several factors may contribute to the breakage of sewers, the important ones being poor foundation, excessive superimposed loads, impact due to vibrations etc.
- (ii) **Clogging:** - The clogging mainly occurs in sewer of small size as it is not possible for a man to enter into such sewer and clean them. The clogging may be due to waste building materials, deposition of sand and grit etc. Clogging is predominant in sewers laid at flat slopes in which self cleansing velocity are not developed.
- (iii) **Odours:** - The organic matter present in sewer decomposes and gives out unpleasant odour.

The structures, which are constructed at suitable intervals along the sewerage system to help its efficient operation and maintenance, are called as sewer appurtenances.

Following are the important sewer appurtenances;

- Manhole
- Drop manhole
- Catch basin
- Street inlets
- Inverted siphons
- Flushing tanks
- Storm regulators

Manhole:

Manholes are masonry/ R.C.C structures, constructed at suitable intervals along the sewer lines, for easy and safety maintenance of the sewage system.

Location of manhole,

- The manholes are provided at every bend, junction, change of gradient or change of diameter of the sewer.
- The sewer line should be straight between two subsequent manholes, as far as possible.
- However due to the local considerations and other factors, the above details can be changed.

Purposes of manhole,

- They permit the entry of man inside the inside the sewer for inspection, cleaning and maintenance purposes.
- The sewer line is divided into small lengths at manholes, that small lengths are called blocks.
- This block provides the facilities of easy location and opening of chokes.
- Manhole help in the ventilation of sewers.
- Manhole joining are used to change the direction of sewer pipe line.
- According to the depth, manholes are divided into three major types;
 - i. Shallow manhole
 - ii. Normal manhole
 - iii. Deep manhole

i. Shallow manhole:

- If the depth of manhole is about 0.75 m to 0.90 m, that manhole is defined as shallow manhole.
- Shallow manholes are used only at the start of the branch sewer, and it is suitable for non-traffic areas.
- It is also known as inspection chamber and it is provided with a lighter cover at its top.

ii. Normal manhole:

- A normal/ medium manhole is about 1.5 m in depth and is constructed either in square of size 1m x 1m or rectangular shape of size 0.8 m x 1.2 m in cross section.
- The section of the normal manholes is not changed with its depth.
- It is provided with heavy cover at the top of the manhole.

iii. Deep manhole:

- A deep manhole is 1.5 m or more than 1.5 min depth and the section of the deep manhole is not kept same.
- Steps are provided in the manhole for enabling the workers going to up to the bottom with a heavy cover at its top.

Parts of manhole:

a. Access shaft :

- The upper portion of the manhole is called access shaft. It has a dimension of lesser than the dimension of the working chamber, located below the access shaft.
-
- Its minimum size is 0.6 m x 0.75 m for a rectangular manhole and 0.75 m diameter for a circular manhole.
- Depth of access shaft = Depth of man hole – height of the working chamber

b. Working chamber :

- The lower portion of a manhole is called working chamber and provides working space to carry out the maintenance and repair works.
- It is constructed by enlarging the size of access shaft at its bottom through an offset by providing a R.C.C. slab, or by corbelling or by arching etc.
-
- The minimum size of the working chamber for a rectangular manhole is about 0.9 m x 1.2 m and that for a circular manhole is about 1.2 m diameter.
- The height of the working chamber should not be less than 1.8 m

c. Bottom or invert :

- The bottom portion of the manhole is called invert / benching and it is constructed by cement concrete.
- It consists of semi-circular / U-shaped main channel and sides are made to slope towards it. The benching permits the entry of sewage from branch sewer to main sewer.

d. Side walls :

- The side walls of a manhole are constructed of either brick / stone masonry/ R.C.C.
- The side walls should be strong to withstand the soil pressure from sides, especially in the case of deep manholes.
- The minimum thickness of wall should be 250 mm and the wall thickness calculated by using the following formula,

$$t = 4d + 10 \text{ (in cm)}$$

Where, d= Depth of excavation (in meters)

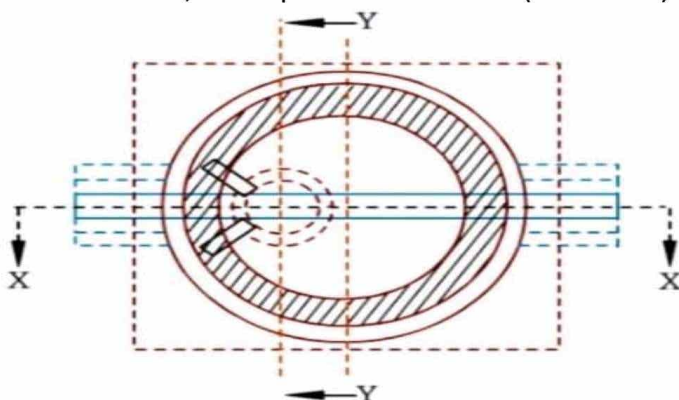

Plan of manhole

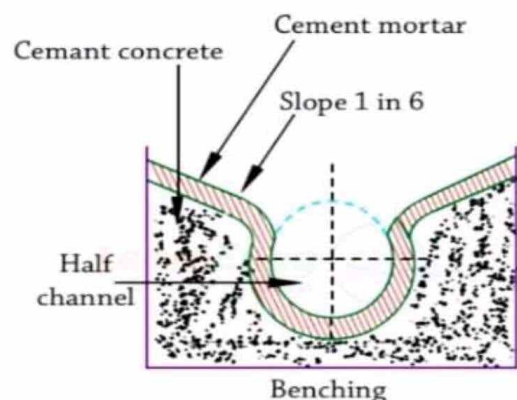

Manhole

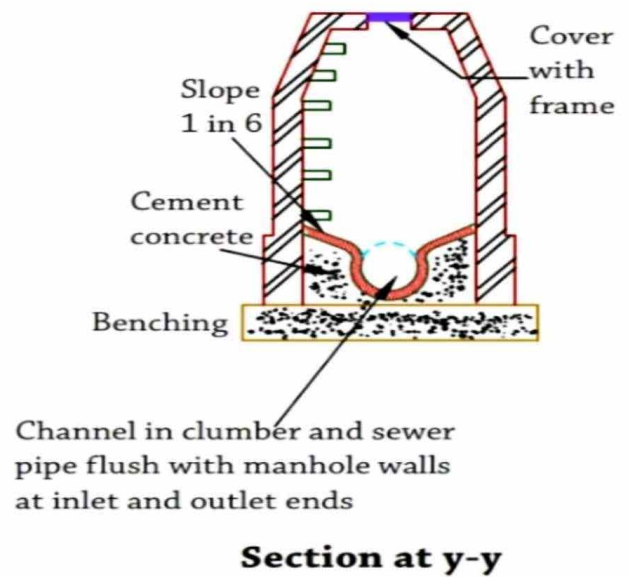
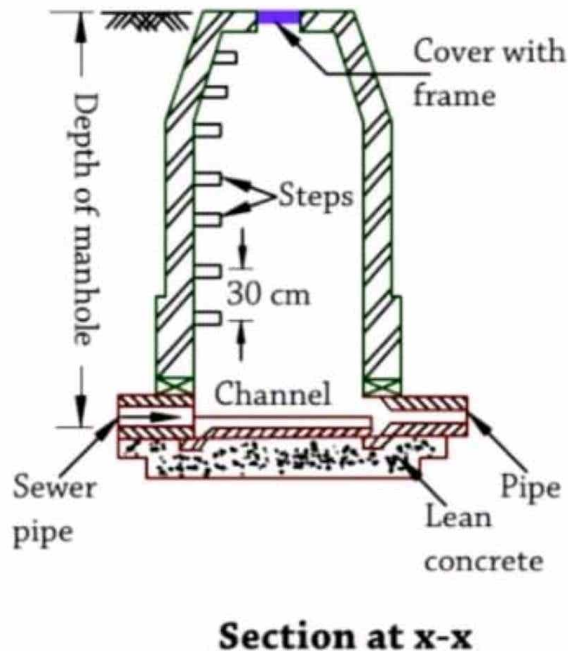

e. Steps or ladder :

- The steps are of small size, placed staggered at horizontally.
- The c/c distance kept as 200 mm, where as vertical distance between the steps will be limited to 300 mm (1 ft)

Drop manhole :

- Drop manhole is a special type of manhole for connecting the high-level branch sewer with low level main sewer.
- If the level of branch sewer is 0.6 m higher than the level of main sewer, the sewage in the branch sewer not allowed to fall directly into the manhole. In order to overcome this problem, two methods are followed.
 - i. The sewage is diverted from branch sewer by, a down pipe taken from branch sewer to the bottom of the bottom of the manhole.
 - ii. By adopting flight sewers.
- The flight sewers are the arrangements, used to control the velocity of sewage by an inclined step drain.
- The sewage of the branch sewer is brought into manhole of main sewer either by 45° inclined pipe or through a vertical down pipe.
- The inclined pipe is called a ramp and the vertical down pipe is called drop manhole.
- The construction of drop manhole avoids the laying of steep gradient of branch sewer and the construction of flight sewer.

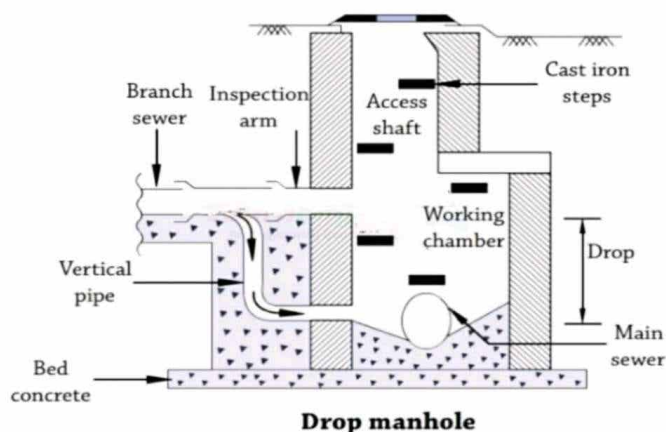

Lamp hole:

Lamp holes are the opening constructed on the straight sewer lines between two manholes which are far apart and permit the insertion of a lamp into the sewer to find out obstructions if any inside the sewers from the next man hole.

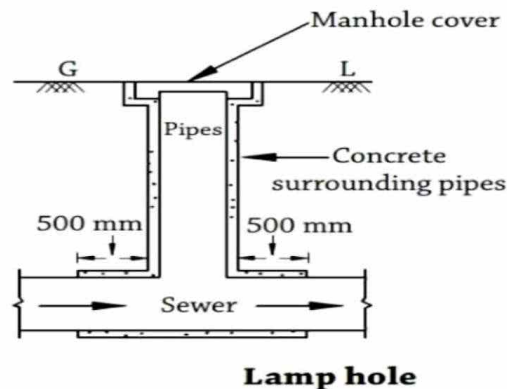

Object of lamp hole:

a. Inspection;

The lamp hole assists in examining the sewer length between adjacent manholes. An electric lamp is inserted in the lamp hole and light of lamp is observed from the manholes.

b. Flushing;

Under some circumstances the lamp hole may be also used as the flushing devices.

c. Ventilation;

If the cover at the top of lamp hole is perforated, the ventilation of sewer is achieved.

d. Location;

The lamp holes are provided at places where,

- A bend in the sewer is necessary.
- Construction of manhole is difficult.
- The spacing of manholes is more than the usual.

Function of Lamp holes:

- It helps in examining the sewer length between adjacent manhole.
- Under some circumstances, it may be used as flushing devices.
- If its top cover is kept perforated, it can be used for ventilation of sewer, such a lamp hole is also known as a fresh air inlet.

Grease and oil trap:

- The sewage from hotels, restaurants, kitchen and industries contain grease, oils and fats, which if not removed before it enters the sewers, will stick to the interior surface of the sewer conduit and will become hard and cause obstruction in the movement of the sewage.
- To check them grease traps are required which are placed in the pipe connecting the kitchen with sewer line.
- Sewage from garages and service stations contains sand, mud, oils and grease which should also be removed before the sewage enters the sewer line.

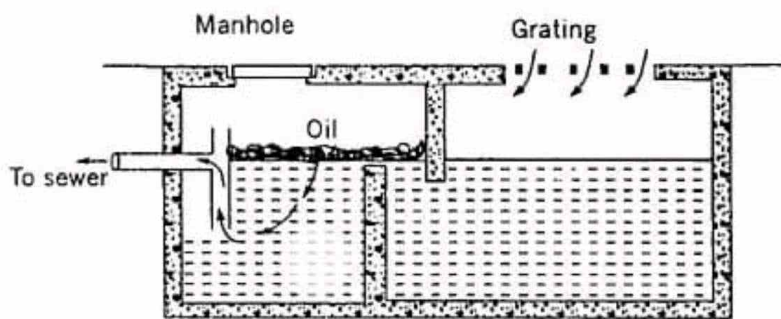

Combined silt and oil trap

Inverted Siphon:

- During laying of sewer in a town, at some places, the hydraulic gradient line falls above the ground surface.
- If there is more depression in the ground and the area is undeveloped or cultivated, sewer line can be laid above the ground by supporting on piers. But sewer cannot be laid above the ground at such places where road, canal and railway line cross the sewer line.
- To overcome such an obstruction in sewer lines, inverted siphons are provided.
- In an inverted siphon the hydraulic gradient line the hydraulic gradient line is above the flow line, whereas in true siphon the hydraulic line is below the flow line.
- Inverted siphons are also known as depressed sewers, because the sewer portion at such portion is below the general sewer line.
- Figure . . . shows the plan and sectional elevation of an inverted siphon.
- The pipe of inverted siphon must be able to withstand the internal pressure.
- The pipe diameter should be such that the sewage may flow with a great velocity to avoid silting.
- The inverted siphons are generally constructed of cast iron or R.C.C.
- At the ends of the inverted siphon manholes are provided for inspection and cleaning purposes. Both inlet and outlet should be given such a slope that the sewage can easily flow.
- The outlet chambers should be so designed as to prevent the back-flow of sewage into pipes which are not being used at the time of minimum flow.

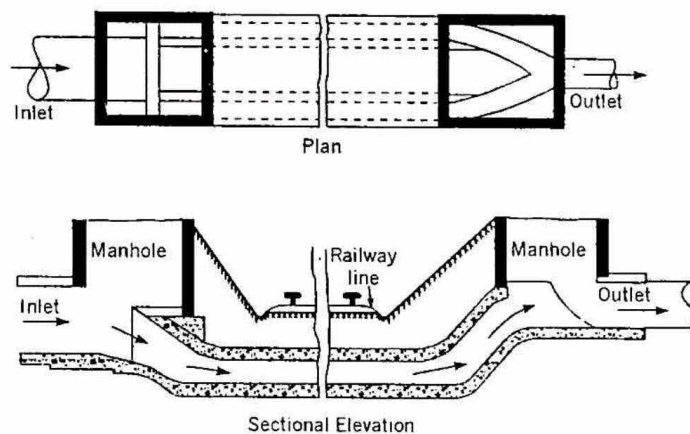

Inverted Syphon

Storm Regulator.:

These are used for preventing overloading of sewers, pumping stations, treatment plants or disposal arrangement, by diverting the excess flow to relief sewer. The overflow device may be side flow or leaping weirs according to the position of the weir, siphon spillways or float actuated gates and valves.

(a) Side flow weir:

- It is constructed along one or both sides of the combined sewer and delivers the excess flow during storm period to relief sewers or natural drainage courses
- The crest of the weir is set at an elevation corresponding to the desired depth of flow in the sewer.
- The weir length must be sufficient long for effective regulation of the flow.

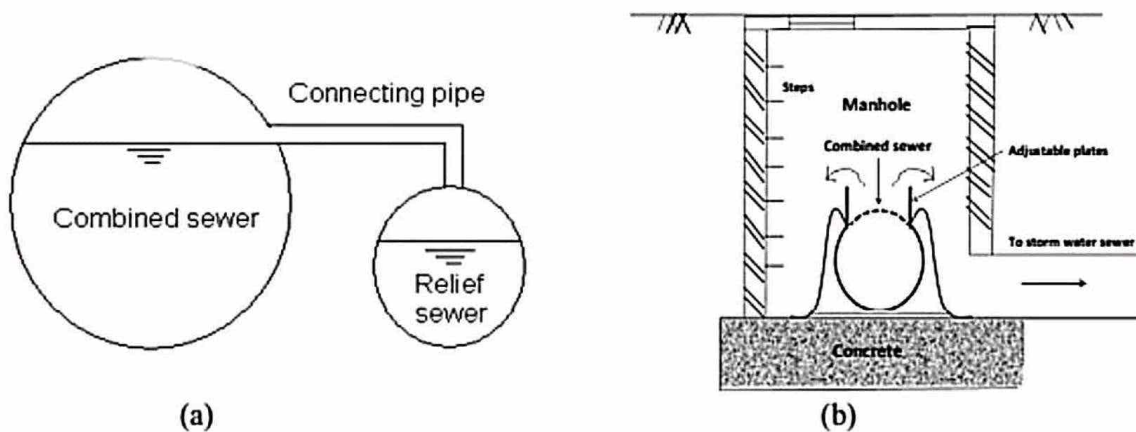

(a) Side flow weir (b) Overflow weir arrangement

(b) Leaping weir:

- The term leaping weir is used to indicate the gap or opening in the invert of a combined sewer.
- The leaping weir is formed by a gap in the invert of a sewer through which the dry weather flow falls and over which a portion of the entire storm leaps.
- This has an advantage of operating as regulator without involving moving parts.
- However, the disadvantage of this weir is that, the grit material gets concentrated in the lower flow channel.
- From practical consideration, it is desirable to have moving crests to make the opening adjustable.
- When discharge is small, the sewage falls directly into the intercepting sewer through the opening. But when the discharge exceeds a certain limit, the excess sewage leaps or jumps across the weir and it is carried to natural stream or river.

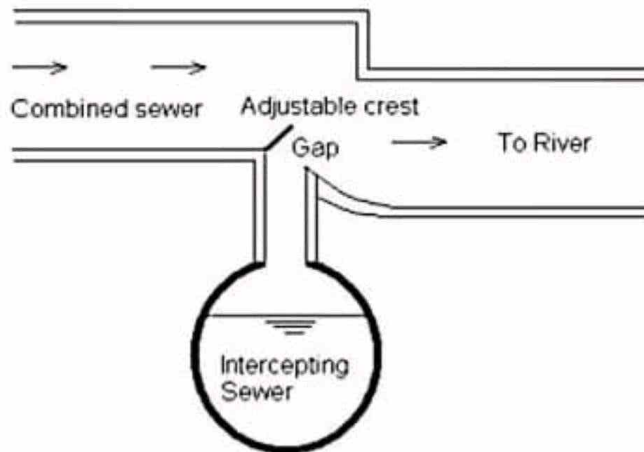

Leaping weir with adjustable crest

(c) Float actuated gates and valves:

- The excess flow in the sewer can also be regulated by means of automatic mechanical regulators.
- These are actuated by the float according to the water level in the sump interconnected to the sewers.
- Since, moving part is involved in this, regular maintenance of this regulator is essential.

(d) Siphon spillway:

- This arrangement of diverting excess sewage from the combined sewer is most effective because it works on the principle of siphon action and it operates automatically.
- The overflow channel is connected to the combined sewer through the siphon.
- An air pipe is provided at the crest level of siphon to activate the siphon when water will reach in the combined sewer at stipulated level

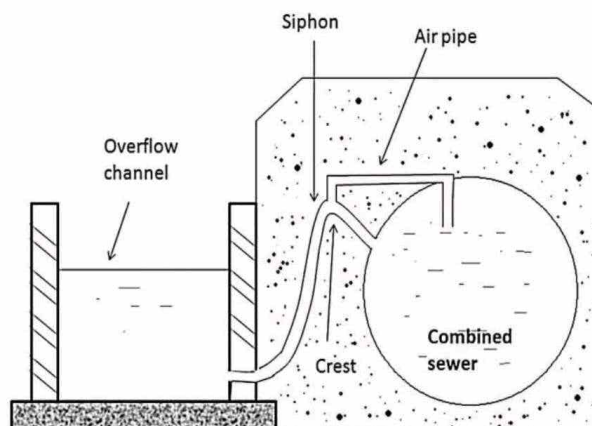

Siphon spillway

Sewage disposal:

The sewage begins to cause nuisance as it becomes stale. So the sewage need to be disposed off without treatment or after suitable treatment . Finally the sewage is disposed off either in natural water course or on land.

DISPOSAL ON LAND:

SEWAGE FARMING

When the sewage is used for growing crops, it is called sewage farming. The nutrients of sewage like nitrogen, phosphorous and potassium along with micronutrients as well as organic matter are directly utilised by the plant. The sewage increases the fertility of the soil along with irrigation potential. The good sewage farm should run on scientific lines with primary objective of disposal of sewage , utilisation to the possible extent in a good sanitary manner without polluting the soil, open water courses or underground water or contamination of the crops or impairing the productivity of the farm and hygienic safety to the staff against the infection by pathogenic organisms. Under no circumstances raw sewage should be applied to the farms directly.

SEWAGE APPLICTION AND DOSING

The sewage can be applied to the land by the following methods.

1. Surface Irrigation

The parallel drains are constructed in the fields. All drains are connected to a distributary drain by means of regulating device so that the sewage can flow in the required drain. This method is suitable in sloppy areas. The sewage is allowed to overflow through fields from one drain towards another.

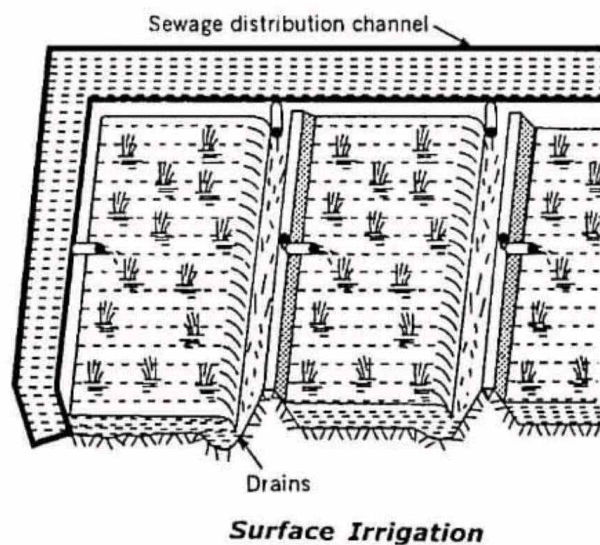

2. Subsoil irrigation

In this method a network of porous open joint pipes is laid about 30cm below the ground level. The sewage is allowed to flow through these pipes which is absorbed by the subsoil. The remaining quantity of sewage, if any, can be used for irrigation to another place or discharged in natural water courses.

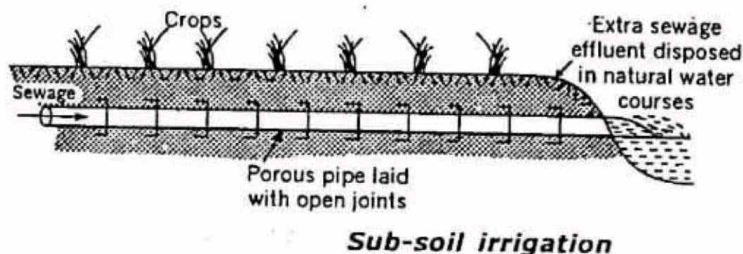

3. Flooding

The irrigation area is divided into various parts surrounded by dykes. The sewage is filled like small ponds in between the dykes as shown in fig. The depth of sewage flooded over the fields varies from few centimetres to 50cm depending on the requirement of the irrigation.

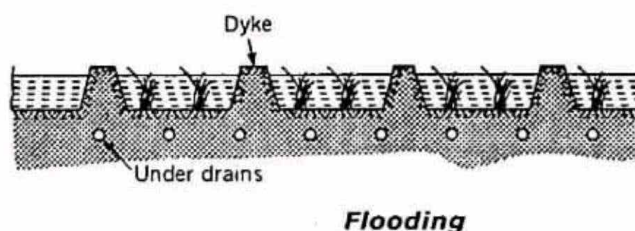

4. Ridge and furrow.

In this method the land is first ploughed deep up to 30cm levelled and divided into plots and subplots. Then each subplot is enclosed by small dykes. Now ridges and furrows are formed in each subplot. The sewage is allowed to flow in furrows, where as crops are grown on ridge as shown in fig. After an interval of 8-10 days the sewage can be again applied depending on the crops requirement and the nature of the soil.

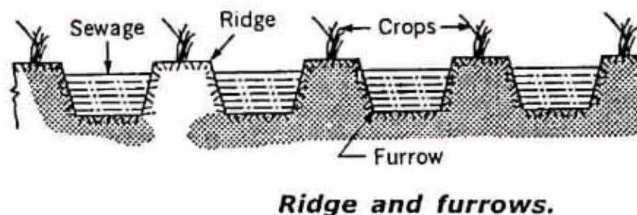

5. Spray irrigation

This method is not used in India . In this method , first the sewage is filled in tanks so that settleable solids may settle. Then the sewage is sprayed over the fields by pumping it through pipes fitted with nozzles at the other end.

SEWAGE SICKNESS

When the sewage is continuously applied on the land, the pores of soil continuously go on decreasing and a stage comes when the soli gets clogged by the deposition of solids of sewage. After reaching this stage , the air cannot circulate through the soli pores, therefore anaerobic conditions cannot continue, resulting in the starting of anaerobic conditions. When anaerobic decompositions start, the hydrogen sulphide gas is produced creating nuisance in the area. In this condition the sewage treating capacity of the land is exhausted and it cannot accept any more load of sewage. When such stage is reached the land is said to be sick.

REMEDIES

- By giving primary treatment to the sewage the suspended solids are removed, due to which the pores of the soil will not be clogged easily.
- By giving rest to the land i.e. intermittent application of sewage on land. The land should be ploughed thoroughly during the non-supply period so that the soil gets aerated.
- By planting different crops in the land in rotation, which will aerate the soli and utilise the fertilising elements of sewage.
- By providing under drainage system to collect the excessive quantity of sewage.
- By frequent ploughing and rotation of soil.

15.2. DISPOSAL BY DILUTION:

The disposal of sewage by discharging it into water courses such as streams, rivers or large body of water such as lake , sea is called **dilution**. This method is only possible when the natural water in required quantity is available near the town.

If the sewage is to be discharged in sea or tidal river water, the required standards for the polluted water are given in table

Class of	Standards of polluted sea or tidal river water	Use of polluted water
A	(i) Full removal of floating solids (ii) M.P.N. of B-coli 100/100ml. (iii) D.C. 50% of saturation value	For fish life development recreation and shell fish culture.
B	(i) Full removal of floating solids (ii) Minimum 10% removal of suspended solids (iii) D.O. 50% of saturation value (iv) M.P.N. of B-coli 100/100ml.	All other use except given in Class A
Class	Standards of polluted water	Use of polluted water

A	B-coli < 50/100ml. Without filtration	For drinking purpose after chlorination
B	B-coli < 100/100ml. No visible sewage	For recreation, bathing and shell fish culture For irrigation and rough industrial use etc.
C	D.O.> 3 to 5 p.p.m and CO ₂ <40	
D	No odour , nuisance and unsightly suspended floating matters. D.O should be present.	

SELF-PURIFICATION OF STREAM

When sewage is discharged into natural waters, its organic matter gets oxidised by the dissolved oxygen content in water. The oxidation of organic matter converts such matter into simple inoffensive substance. The deficiency of dissolved oxygen thus created in natural waters is filled up by the absorption of atmospheric oxygen. Thus the oxygen of water is consumed by the sewage and at the same time , it is replenished by the atmosphere. This phenomena which occurs in all natural waters is known as the *self-purification* of natural waters.

The rate of self-purification will depend on various factors such as rate of re-aeration , type of organic matter present in sewage, temperature, velocity of flow, presence of available oxygen in receiving waters, sedimentation etc. The self-purification process of streams polluted by sewage can be grouped in following four zones.

1. Degradation Zone

This zone is situated just near the point of entering sewage into the stream. The water is turbid with dark colour. The decomposition of soil matters takes place in this zone and the anaerobic decomposition prevail.

2. Active decomposition Zone

In this zone the water is greyish and darker than the previous zone. The objectionable odours of hydrogen sulphide and other sulphur compounds prevail and scum may also be seen on the surface in this zone.

3. Recovery zone

In this zone the stabilization of organic matter s takes place and the B.O.D of water is reduced . the contents of dissolved oxygen start rising up above 40% of the saturation value. The bacterial load decreases as the food supply of bacteria diminishes.

4. Clear water Zone

In this zone the stream attains normal conditions as were prevailing before sewage is discharged into it.

Principles of treatment of industrial wastewater :

Treatment of industrial waste water may consist of the following process;

- Reduction of volume and strength
- Equalization
- Neutralization
- Proportioning
- Physical treatment
- Chemical treatment
- Biological treatment

Sewage contains various types of impurities and disease bacteria. This sewage is disposed of by dilution or on land after its collection and conveyance. If the sewage is directly disposed of, it will be acted upon the natural forces, which will convert it into harmless substances. The natural forces of purification cannot purify any amount sewage within specified time. If the quantity of sewage is more, then receiving water will become or the land will become sewage sick. Under such circumstances it becomes essential to do some treatment of sewage, so that it can be accepted by the land or receiving water without any objection.

Thus the main objective of the treatment units to reduce the sewage contents from the sewage and remove the entire nuisance in such a way that it can be safely discharged in the natural water course applied on the land.

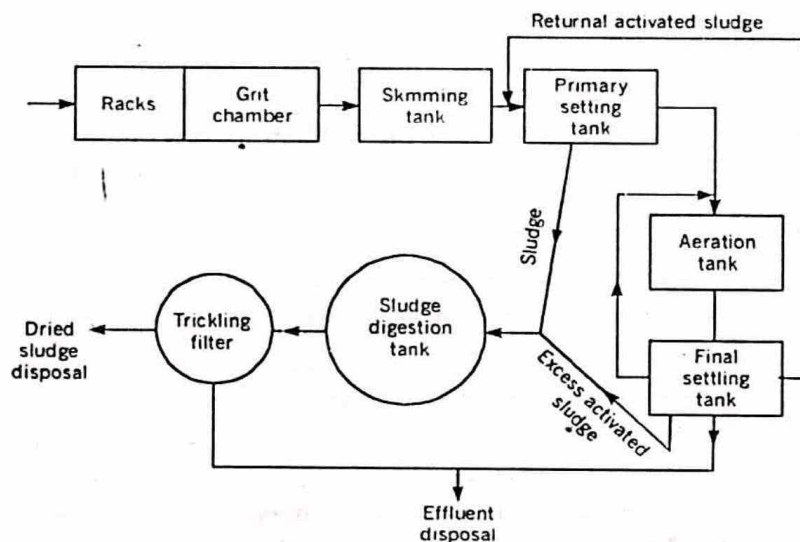
FLOW DIAGRAM OF CONVENTIONAL TREATMENT**1. PRIMARY TREATMENT**

The sewage contains various suspended, floating, and oily substances. By primary treatment these substances are removed from the sewage so that the working of the sedimentary treatment units may be easy and there are no disturbances in the operation of those units. The units of the primary treatments are as follows:

SCREENS

The screen is the first unit of primary treatment plant. The function of screen is to remove all the floating debris like wood pieces, cloth and paper pieces, decayed fruits and vegetables etc. If these floating matters are not eliminated, it may choke the pipe lines or it may cause damage to the pumping unit.

Construction: The screens may be constructed of M.S bars or rods, gratings, wire meshes or perforated plates. The M.S. bar screen is made by placing parallel bars with spacings according to the following types.

Coarse screen: The spacing of bars is more than 40mm centre to centre.

Medium screen: The spacing of bars is less than 40mm.

Fine screen: The spacing of bars vary from 1.5mm to 6mm.

The screens may be fixed or movable. The inclination of the screen varies from 30° to 60° . The screens are placed at designed inclination in an oblong rectangular chamber. The ends of the chamber are tapered. It is constructed with brick masonry. The inner surfaces are plastered and finished with neat cement polish. A perforated rectangular channel is provided at the top of the screen for collecting floating debris.

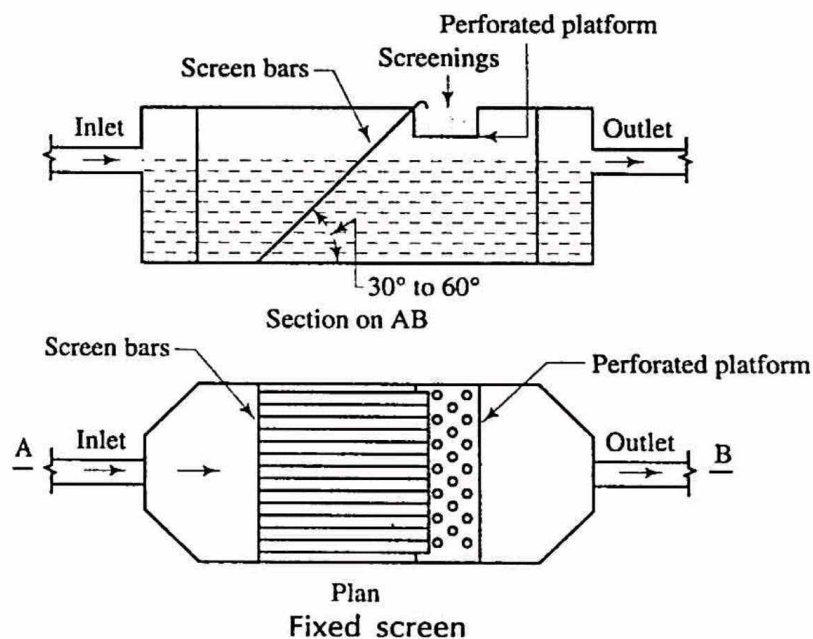

Operation: The raw sewage is allowed to enter the chamber through the inlet pipe. The floating debris are obstructed by the screen and collected near it. The sewage containing the other suspended materials passes through the screen and is taken to the next unit.

Cleaning: The debris may be cleaned by manual labours or mechanical device. In manual system, the debris are taken by rakers and collected in the perforated channel from where these are disposed of. In mechanical device system, a raking arm like crane is provided which

collect the debris at regular interval and throws in a collecting basin from where these are disposed of.

Disposal

Dumping : The debris are dumped in low-lying areas far away from the locality.

Burning: After drying the debris are burnt to ashes.

Composting: Good quality manure may be obtained by composting the debris in compost plant.

GRIT CHAMBER

The function of grit chamber is to remove the inorganic substances like grit, sand and other suspended materials. The velocity of flow in the grit chamber is kept low so that a detention period is available for the settlement of the above substances.

Construction The grit chamber is an oblong rectangular chamber and constructed with brick masonry. As shown in fig the floor of the chamber is made sloping for the collection of grits at a particular zone. The inner surfaces are plastered and finished with neat cement polish. It consists of an agitator for agitating the deposited grit at the time of cleaning. A pipe line with valve is provided at the bottom of the chamber for periodical removal of the grits. The length, width and depth are designed according to the volume of sewage.

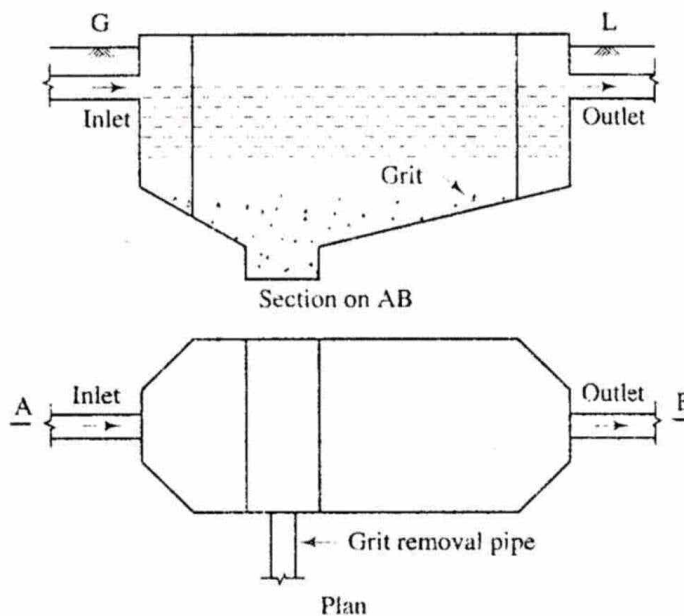

Grit chamber with direct flow

Operation: The sewage from the screen chamber is allowed to enter the grit chamber and flow at a low velocity of 20 cm to 30 cm per sec. Due to the low velocity; the grits, sands, etc are settled down at the bottom of the grit chamber.

Cleaning: At the time of cleaning, the deposited grits are agitated by agitator and the muddy water comes out through the removal pipe. The grits may also be cleared from top by manual labours with the help of buckets.

Disposal The grits are generally dumped in low-lying areas for the reclamation of land.

PRIMARY SEDIMENTATION TANK

The function of primary sedimentation tank is to remove colloidal particles like silt and clay and some organic substance. Moreover it reduces the load on the secondary treatment. Coagulants may be used, if necessary.

Construction: It is a rectangular tank constructed with brick masonry. Baffle walls are provided in zigzag way so as to lengthen the path of the flow of the sewage. Inlet and outlet pipes are provided on opposite corners and these are provided with valves. A sludge removal pipe is provided at the bottom of the tank.

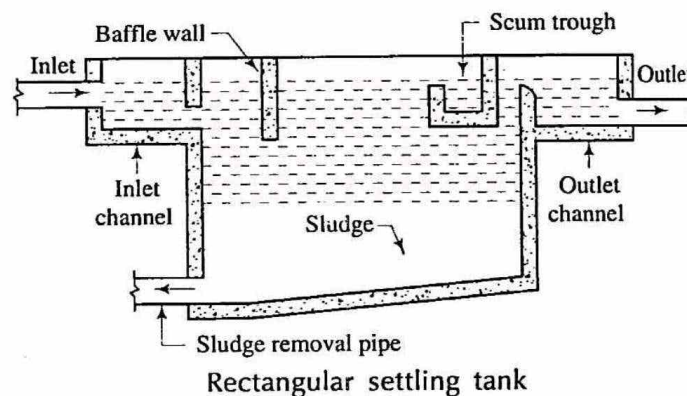

Operation: The sewage enters the tank through the inlet pipe and flows along the zigzag path and hence the velocity of flow is reduced. Thus the sewage is detained for a considerable period in the tank. The colloidal particles and organic substances are settled down at the bottom of the tank. The comparatively clear water passes out through the outlet pipe.

Cleaning: The sludge is cleaned periodically through the removal pipe by opening the valve.

Disposal: The sludge may be disposed of by pumping in ditches or low-lying areas or may be dried in sludge drying beds and can be used as manure.

2. SECONDARY TREATMENT :

In the primary treatment, the larger solids in sewage are removed. But the effluent still contains organic matters, bacteria, colloidal matters etc. Such effluent cannot be discharged into the natural water course. So secondary treatments are given to the effluent of primary treatment to make it safe in all respects and suitable for discharging it into the river. The units of the secondary treatments are as follows:

CONTACT BED

Contact bed is a method of filtration of sewage. Its rate of filtration is low. In contact bed, the sewage is brought in contact with the filtering media for some specified period. During this period, a biological film is formed around the particles of the filter media and the bacterial colonies are formed in the film. These bacteria are responsible for the oxidation of organic matters. Again, when the bed is kept empty for some period, the filter gets oxygen from atmosphere and oxides the organic matters if they remain deoxidised.

Construction: It is a rectangular tank which is divided into several beds. The depth of bed varies from 1m to 2m. Each bed is filled up with filtering media of gravel, ballast or broken stones as shown in fig. The effective size of ballast varies from 15mm to 50mm. A siphonic dosing tank is provided for the supply of sewage to all the bed simultaneously. Generally the rate of filtration is 500 litres per m³ of filter media.

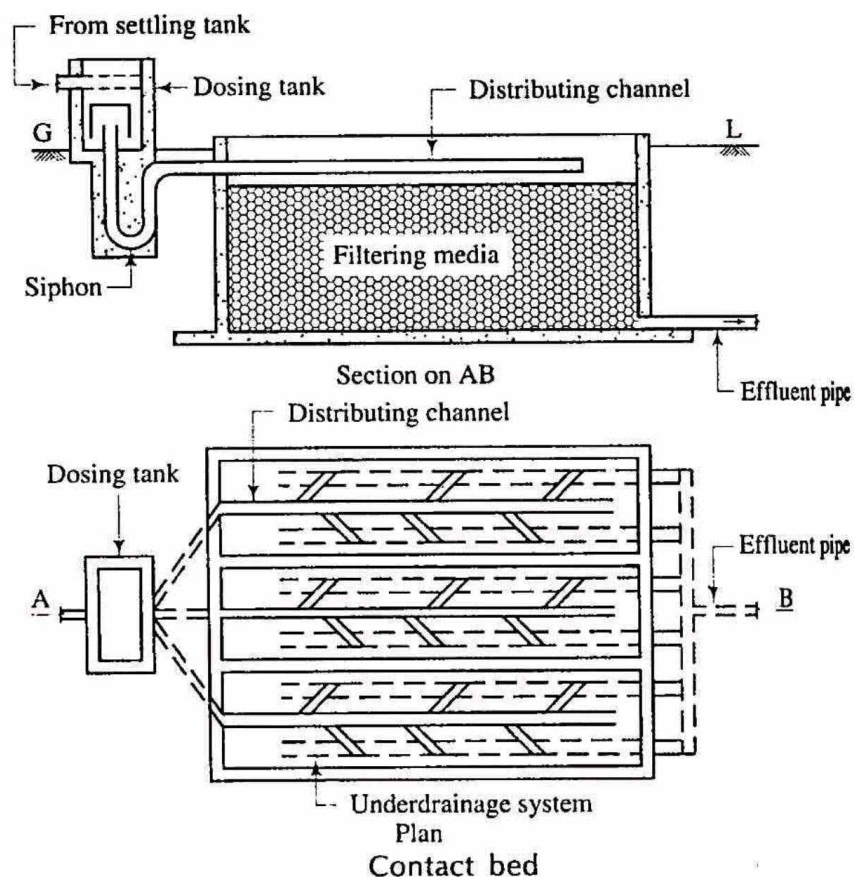

Operation: The bed is filled with sewage through the siphonic dosing tank and it may take about two hours. The sewage is allowed to stay in the filter media for about 2 hours. The effluent is allowed to flow through the effluent pipe for the disposal to natural water course. This may take about 2 hours. The bed is allowed to stay empty for about 4 hours. Thus, the cycle of operation continues during the working period.

TRICKLING FILTER

Trickling filter is a method of filtration of sewage. The rate filtration is high as compared to contact bed. The principle of trickling filter is that the bacterial film which is formed around

the filtering media is the source of formation of the bacterial colonies. These bacteria decompose the organic matters for their survival. So the trickling filter serves the purpose of breaking the complex organic matter by fertilising the bacteria.

Elements of trickling filter

Construction of filter: Generally the trickling filter is circular in shape. It consists of 4 nos. of rotary distributing arms which have perforation at the bottom. The arms are fitted with a central support which is rotated by a suitable device. The floor of the filter is made of concrete and its slope is made towards the periphery.

Dosing of filter: A siphonic dosing tank is provided with the trickling filter for intermittent supply of effluent over the filtering media.

Filtering media: It consists of broken stones, clinkers etc with their size varying from 20-50mm. The larger size stones are placed at the bottom layer and the smaller size stones are arranged towards the top. the stones or clinkers should of good quality.

Under drainage system: It consists of a channel along the periphery of the filter. The channel is again connected to the outlet pipe.

Ventilation: The ventilation of the filter is necessary for the smooth working of the filter. The ventilation is achieved by providing vent pipes at the periphery.

Working: The effluent is spread over the filtering media of broken stones by rotary arms. The effluent trickles down the media and gets collected in the channel. The channel carries the effluent to the outlet pipe through which the effluent is taken for chlorination.

Cleaning: After working for long period, the upper surface of the media may be clogged by sediments. The rate of filtration may be decreased or stopped due to this. At that time , the upper layer of stones are scrapped off and fresh layer of stones of same size are replaced properly.

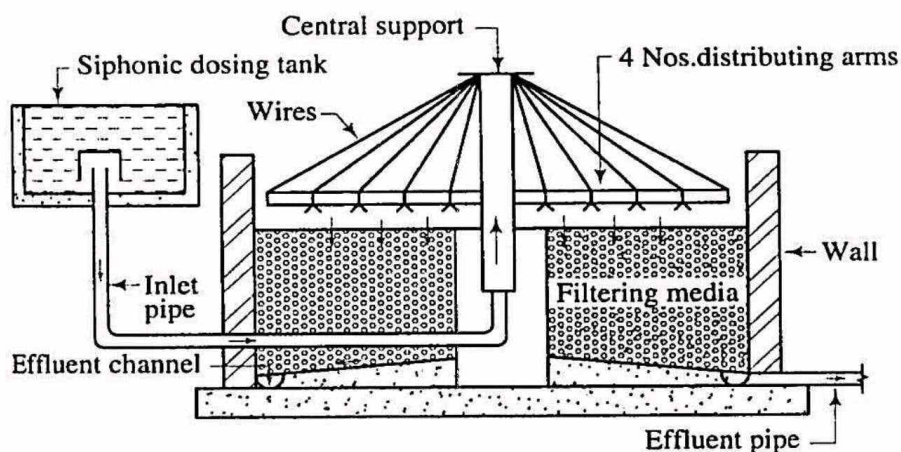

Circular trickling filter

ACTIVATED SLUDGE PROCESS

Definition

The sludge which is made powerful by the process of aeration is known as activated sludge. It contains high content of oxygen and high no. of aerobic bacteria. It possesses unusual property to oxidise the organic matters.

Action

The following are the actions of activated sludge:

- (i) The activated sludge when mixed with sewage, the microorganisms multiply rapidly.
- (ii) The activated sludge oxidises the organic substances rapidly.
- (iii) It converts the colloidal matters to settleable size rapidly.

Operational features

1. **Mixing of activated sludge** : Some portion of the activated sludge settled at the bottom of secondary settling tank is recirculated and mixed with the effluent of primary settling tank just before its entry to the aeration tank.
2. **Aeration**: Aeration tank is the first unit of the activated sludge process. Here, the effluent of the primary settling tank and air are brought in intimate contact by agitating with some mechanical devices. The devices are as follows:
 - a) Air diffuser system
 - b) Mechanical aeration system
 - c) Combination of Air diffuser and mechanical aeration system

Air diffuser system may be achieved by (i) Jet diffuser (ii) Plate diffuser (iii) Tube diffuser

Sludge settlement: The secondary sedimentation tank is the second unit. After agitation in aeration tank, the effluent is taken to the secondary settling tank and detained for a specified period, generally of 1 hr. During this detention period, the sludge is termed as activated sludge. Some portion of this sludge is recirculated to aeration tank and the remaining portion is sent to digestion tank. Thus, the cycle of activated sludge process goes on working.

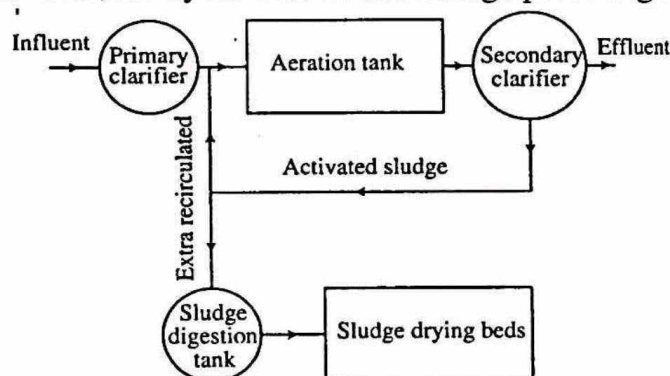

Flow diagram of activated sludge process

AERATED LAGOON

An aerated lagoon is an earthen basin about 2.5m to 4.0m deep, in which the sewage is filled and aerated by means of diffused air or mechanical aerators. Commonly mechanical aerators are used. These are firmly fixed on the permanent foundation. Sewage is sent in the lagoon after passing through the grit chamber, without giving any primary treatment. The aerated lagoon acts as a settling cum aeration tank, where artificial aeration replaces algae oxygenation of the waste stabilized ponds. The detention period of 3 to 5 days is provided. The efficiency of aerated lagoon is 70 to 95% B.O.D removal. These are most suitable for middle size town as the initial cost of construction varies from Rs. 15 to 25 per capita. The waste water of industries such as paper, straw board and food industries can also be easily treated by aerated lagoons.

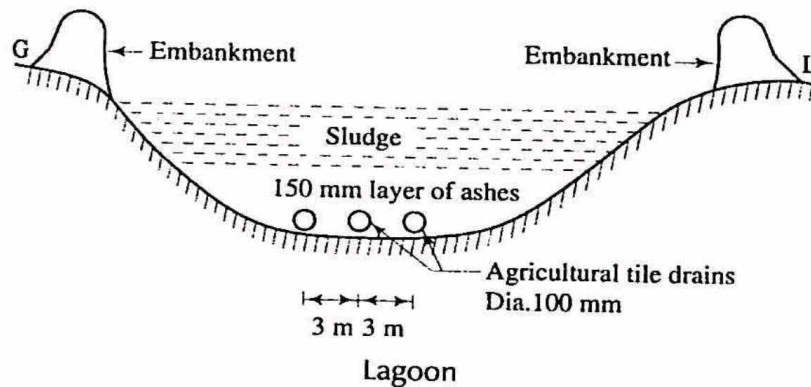

OXIDATION DITCH

The oxidation ditches are aeration units in the shape of long channels 150 to 1000m long, 1 to 5m wide and 1 to 1.5m deep. mechanical aeration devices mainly consists of cylindrical cage about 75cm in diameter made of C.I., angle iron webs on which short (15cmx5cmx5cm), Tees or angle irons are mounted. These cylinders are kept at such a level that about 10 to 15 cm of them dipped in sewage. These cylinders are rotated at about 75 *r.p.m*. The rotor aerator aerates the sewage at a velocity of more than 30 cm/sec and keeps the solid content of the sewage in suspension condition. After aeration the sewage is allowed to settle in the settling tanks. The activated sludge is returned back to the aeration units. No primary treatments are given to sewage, so the methods are cross simplified. Sometime it acts as a settling unit. The rotors are stopped for 2 hours and the suspended solids settle in the bed, the effluent is taken out and disposed.

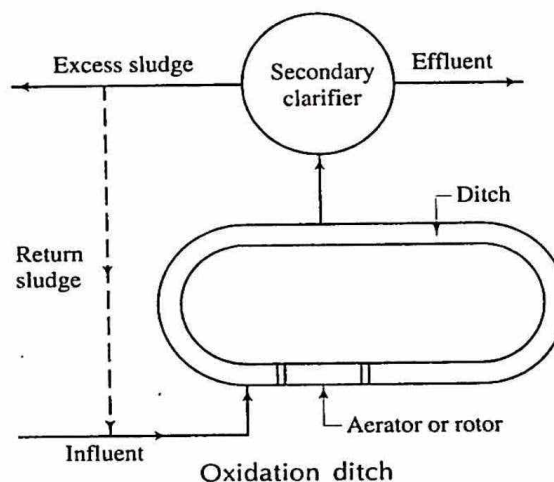

SLUDGE DISPOSAL:

Before disposing the sludge, the sludge digestion is to be done.

SLUDGE DIGESTION

The decomposition of complex organic matters in sludge by the bio-chemical reactions created by anaerobic bacteria is termed as sludge digestion. A portion of solids is converted into liquid and gases due to which the volume is reduced by 60-75%.

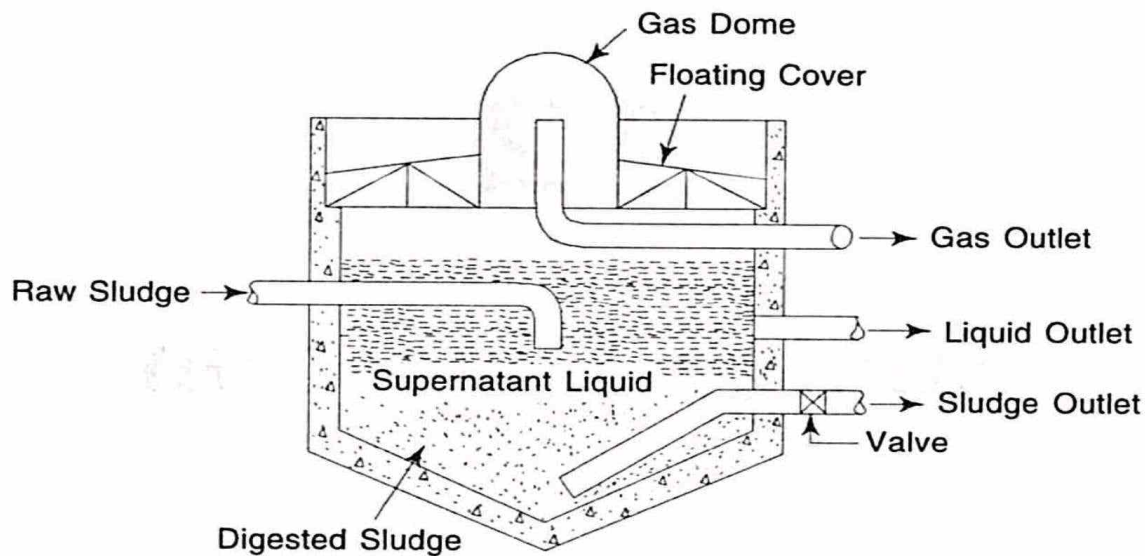

Necessity of Sludge Digestion: The following are the necessity of sludge digestion

- To destroy pathogenic bacteria.
- To reduce the volume of sludge so that it can be disposed of easily.
- To obtain combustible gases.
- To obtain good fertiliser.
- To reduce the moisture content for the facility of handling and transporting.

The sludge digestion is done in sludge digesters. There are 2 types of sludge digesters.

SLUDGE DIGESTION TANK

Constructional features

1. Enclosure tank : The enclosure tank is generally circular in shape and is constructed with R.C.C. The diameter of the tank is varies from 5-20 m and depth varies from 3-5m. however the actual size depends upon in the volume of the sludge. The floor of the tank is made sloping like hopper and the slope is generally 1:2 or 1:3.

2. Gas Dome: A gas dome is provided with the floating roof for the collection of gas formed during the process of digestion.

3. Inlet and Outlet: An inlet pipe is provided for the entry of raw sludge. A sludge outlet pipe is provided at the bottom. Supernatant liquid outlets are provided at different levels. A gas outlet pipe is provided at the top for drawing the gases from dome.

4. Mixing Device: A suitable mixing device should be provided for mixing the incoming raw sludge with the digested sludge.

5. Scum breaking device: Some devices should be provided to break up the scum which may form at the top surface.

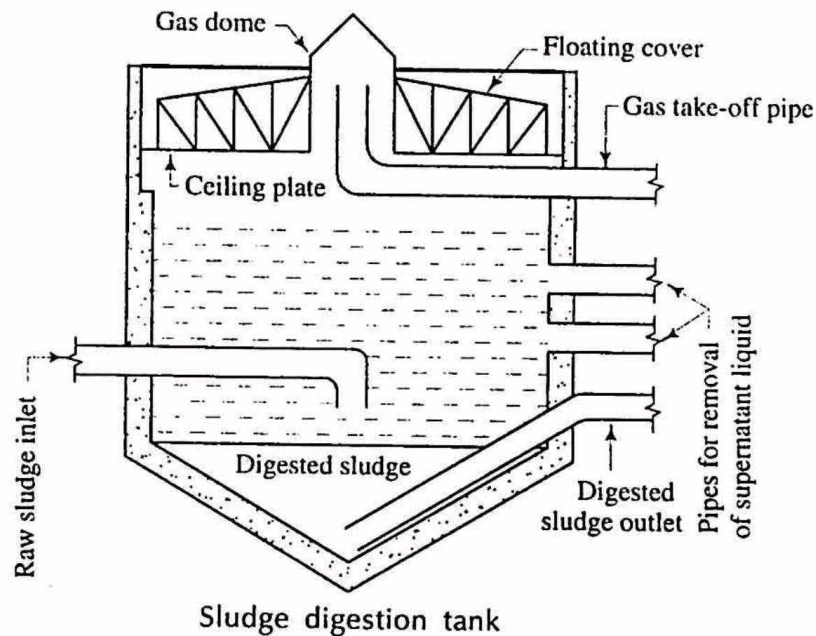

Working principles

1. The raw sludge is allowed to enter the tank through the inlet pipe and is thrown at the centre of the tank.
2. The sludge is digested by the decomposition of complex organic matters by anaerobic bacteria.
3. The digested sludge is settled at the bottom of the tank which is withdrawn through the outlet valve and left for drying. The gases are collected at the dome. The gases are withdrawn through the outlet pipe and are used as fuel.
4. The supernatant liquid is collected, at the space between the digested sludge zone and the gas dome. This illiquid is withdrawn from different levels and disposed of in the natural water course.

DISPOSAL OF DIGESTED SLUDGE

The sludge obtained from all the sources has an objectionable odour and it possesses the property of pollution if not properly disposed of. The following are the methods of sludge disposal.

1. The sludge is disposed by spreading on drying bed to a thickness of 30cm. After 7 days, the sludge is ready to removed and stored suitably for the use as manure. It should not come in contact with vegetables and fruits directly on soil.
2. The sludge is disposed by spreading over barren land at an interval of about 7 months and ploughed frequently which enhances the fertility of the land.
3. The sludge is disposed by pouring in trenches on barren land. The trenches are excavated on land perpendicular to each other at an interval of disposal period (about 1 month).
4. Where there is no utility of sludge, very easy and cheap method of sludge disposal is throwing the sludge into the deep sea very far away from the shore ensuring that the sludge may not return to the shore.

5. The sludge is disposed by incineration. The sludge is burnt in incinerator of flash type (consists of a tower) or multiple hearth type (consists of a furnace). Ashes from incinerated sludge is used as a landfill .
6. Lagooning is one of the process of sludge disposal. A lagoon is an artificial pond of depth of about 1m with the embankments on 2 sides. The lagoon is filled up with wet sludge and left for few months. The sludge is dried and cracks are formed on the surface. Then the dried sludge is removed and used as manure. This is a very cheap method, if sufficient land is available.

ISOLATED TREATMENT UNITS

SEPTIC TANK

1.Theory : Septic tank is based on the principle of sedimentation of sewage and digestion of sludge. In this tank the sewage is detained for some period. During this detention period, the sewage is decomposed by anaerobic bacteria and the sludge is deposited at the bottom (as sedimentation tank). The digestion of sludge is carried out by the anaerobic bacteria (as digestion tank). The effluent is clear and it is discharged into the soak pit constructed at a suitable place.

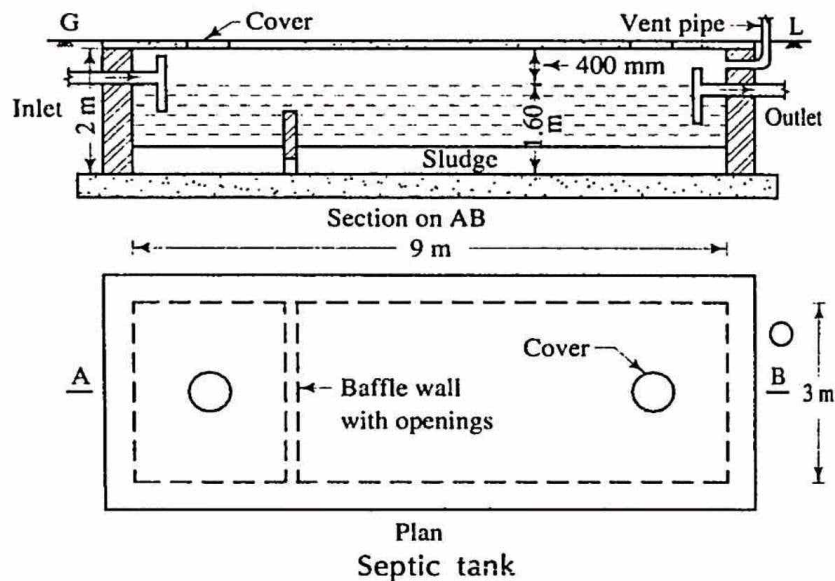

2.Use : the septic tank is suitable for the towns where it is not possible to establish the water carriage system. It is provided in residential buildings, hostels, hotels, hospitals, schools, colleges, etc.

3.Constructional features: Fig shows a septic tank. The following are the constructional features of septic tank:

- (i) It is a rectangular tank constructed with brick masonry over concrete foundation. The length is usually 3 times the breadth.
- (ii) The liquid depth varies from 100-180 cm.
- (iii) A free board of 30-50-cm is provided above the liquid level.

(iv) The inlet pipe and outlet pipe consist of 'T' or 'elbow' which are submerged to a depth of about 25cm below the liquid level

(v) The outlet level is about 15cm lower than the inlet level.

(vi) The inside surface of tank should be plastered and finished with neat cement polish to make it complete watertight.

(vii) For smaller tank single baffle wall should be provided. But for larger tank two baffles should be provided near both the ends.

(viii) The top of the baffle should be at least 15cm above the liquid level.

(ix) Openings should be provided near the bottom of the baffle for the flow of effluent from first chamber to second chamber. Sometimes, hanging baffles may be provided.

(x) R.C.C. slab with manhole is provided at the top of the tank.

(xi) Ventilation pipe is provided for the removal of foul gas.

4. Working Of Septic Tank: The fresh sewage from the latrines enters the first chamber directly where the scum start floating at the beginning. Within few days, the anaerobic bacteria decompose the scum and sludge is formed which is settled down at the bottom of the tank, and it is digested further by those bacteria. The effluent from the first chamber flows to the second chamber through the opening in the baffle wall and finally disposed of to the soak pit. During the decomposition, the gases like carbon dioxide, methane and hydrogen sulphide are formed which are released through the vent pipe.

Due to the deposition of sludge, the capacity of the tank goes on reducing gradually. So, the tank should be cleared every year, or at some reasonable period.

5. Design Aspects: Following are the design aspects of the septic tanks:

(i) **Capacity:** The volume of septic tank is decided by taking into consideration the quantity of flow and detention period. It can also be designed on per capita basis which varies from 60-110 litres person to be served by the septic tank. The pace for sludge is kept usually at the rate of 15 to 45 litres per capita per year.

(ii) **Detention Period:** The detention period varies from 12 to 72 hours, the common being 24 hours.

(iii) **Freeboard:** This should be about 400mm to 600mm.

(iv) **Shape:** The septic tanks are generally rectangular in shape . The ratio of length to width is about 2 to 4.

SOAK PIT/ SOAK TRENCH

Function: The function of soak pit is to receive effluent from the septic tank and disperse the liquid to the surrounding soil through the openings provided at the wall and through the bottom. The soak pit should not be constructed very near to an open well or tube well.

Constructional Features: The following are the constructional features of the soak pit:

(i) The soak pit is constructed with brick masonry in the shape of a square or circle. The depth varies from 3-5m. But the depth depends upon the water table of the locality. It should be remembered that the depth should not be taken below the water table.

(ii) The diameter of the pit depends on the volume of effluent and number of users. However, the diameter varies from 1-2m.

(iii) Openings are provided on the wall of the pit, as shown in fig. The bottom is kept open so that the water can be absorbed by the surrounding soil.

(iv) The pit may be hollow or filled up with brick bats and brick khoa.

(v) Sometimes, a packing of coarse sand (15 cm thick) is provided around the pit to increase the percolating capacity of the soil.

(vi) If the soaking capacity of the pit is destroyed, it should be cleaned and filling materials may be replaced.

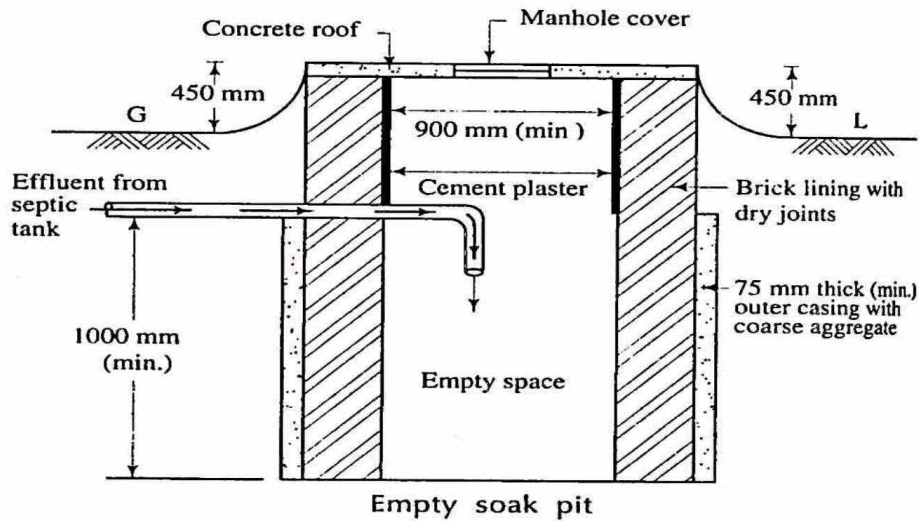

OXIDATION POND

Theory The oxidation pond is an excavation of rectangular ditch of shallow depth. The sewage is stored in this pond for a considerable time. During this period, the sewage is decomposed by the action of aerobic bacteria, algae and sunshine. That means, it is a natural method of sewage treatment. The aerobic bacteria absorb oxygen from the atmosphere for their survival and break up the organic matters in sewage to simple stable compounds.

Construction and Operation The oxidation pond is constructed by excavating a rectangular ditch of shallow depth. The length varies from 50-100m, the width from 30-50m and the depth varies from 0.9-1.5m. The pond is divided into several compartments. The sewage is allowed to enter the pond through the inlet channel at one corner. The sewage flows in a zig-zag manner until the whole pond is filled up. The detention period varies from 7-14 days. The decomposition of sewage is achieved by the aerobic bacteria. After complete decomposition black humus is obtained which may be used as manure.

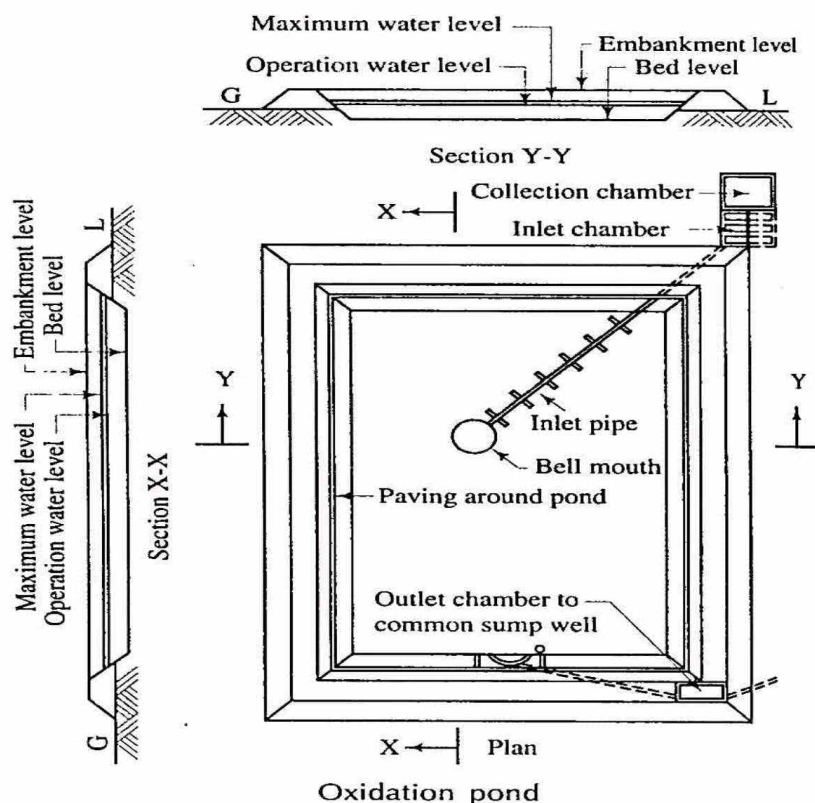

Advantages

- (a) It is a natural method of decomposition, so it is cheap.
- (b) Its operation and maintenance is simple.
- (c) It is highly efficient in removing B.O.D.

Disadvantages

- (a) Large area is required for treatment.
- (b) It creates bad smell and mosquito nuisance.
- (c) In rainy season or cloudy weather, the sewage becomes septic and this may cause insanitary condition.

Requirements of building drainage

- (1) It is advisable to lay sewers by the side of building rather than below the building.
- (2) The drains should be laid straight between inspection Chambers or manholes. All sharp Bends and junctions should be avoided except through chambers or manholes.
- (3) The house drain should be connected to the public sewer only if the level permits i.e., only when public sewer is Deeper than the house drain. Otherwise there will be reverse flow from the public sewer to the house drain.
- (4) The entire system should be properly ventilated from the starting point to the final point of disposal.
- (5) The house drainage should contain enough number of traps at suitable points for efficient functioning of it.
- (6) The house drain should be disconnected from the public by the provision of an intercepting trap so as not to allow foul gases from the public sewer to enter the house drain.
- (7) The joints of sewers should be watertight and properly tested before putting the drainage line n use.
- (8) The lateral sewers should be laid at proper gradation so that they will develop self-cleansing velocity.
- (9) The layout of house drainage system should permit easy cleaning and removal of obstructions.
- (10) The materials of sewer should comply with the standard requirements. They should be non-absorbent and an earth cushioning should be provided to protect them from external loads.
- (11) The possibilities of formation of air locks, siphonage, undue deposits, etc. should be properly studied and remedies should be accommodated in the design to avoid them.
- (12) The rain water from houses is collected from roofs and it is allowed to flow freely on the road surface basins or inlets to convey it to the storm water drain.
- (13) The sewage formed should be conveyed as possible after its formation.
- (14) The size of lateral sewers should be such that not overflow at the time of maximum discharge.

DRAINAGE PLANS OF BUILDINGS:

It is necessary to prepare the detailed plans showing the proposed house drainage system and to get it approved or sanctioned from the competent authority. Following points should be noted:

- (1) The site plan of the building should be drawn to the convenient scale and positions of gully marked on it
- (2) The longitudinal section of proposed sewer line should show distances drawn to a convenient scale. Generally the longitudinal sections of drains greater than 150 mm in diameter drawn.
- (3) The longitudinal sections should show distances, ground levels, invert levels, depths of cutting, sizes of chambers and manholes, size and gradient of pipes, etc.
- (4) The position of public sewer should be clearly shown the site plan and longitudinal section of drain. It is advised to join the house drain to a manhole on public sewer

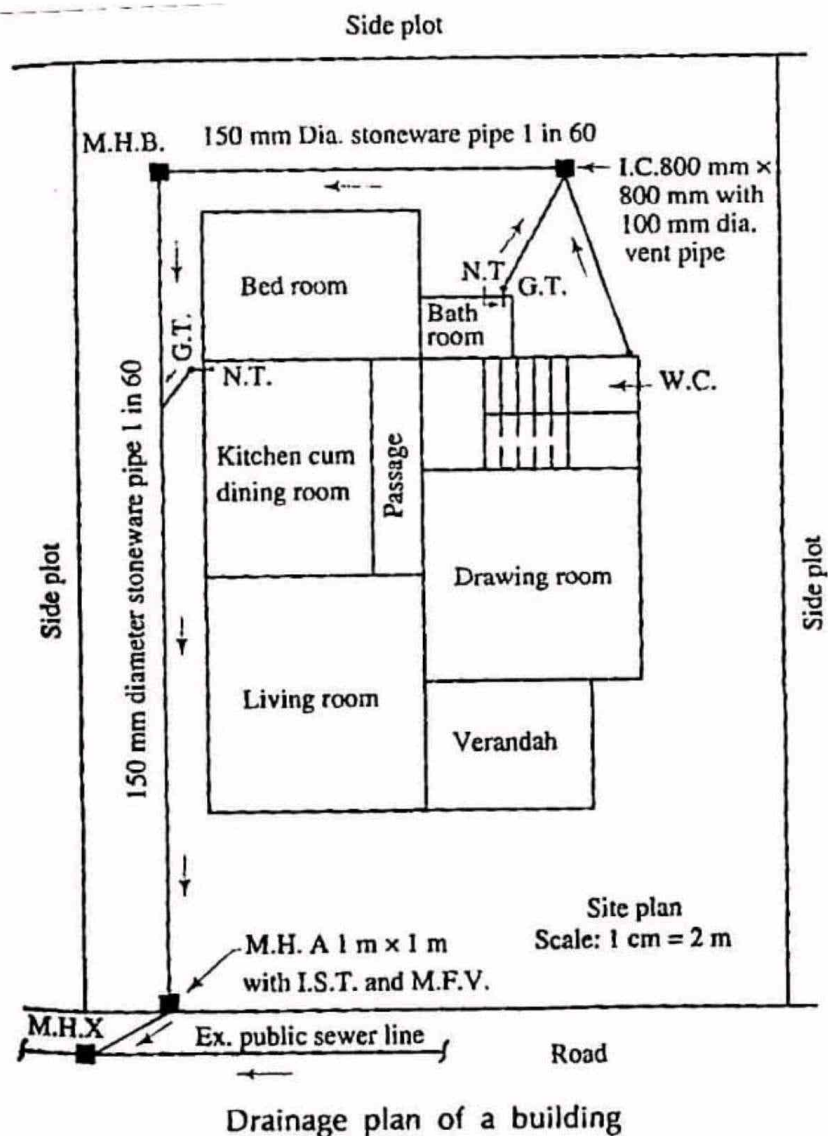

Drainage plan of a building

LAYOUT OF LAVATORY BLOCKS IN RESIDENTIAL BUILDING

The scale of provision of sanitary facilities in a building will be dictated by the nature and size of the building, the overall building occupancy, gender ratio, and particular patterns of use. These factors should be considered alongside the diversity of building user needs to establish the range, location, and type of facilities that will provide access for all.

The number and range of sanitary appliances should be established at an early stage in the design process and should involve consultation with users as well as with the local planning, building control and environmental health, and relevant licensing authorities, where applicable.

The gender ratio should take account of the likely proportion of males and females but also acknowledge the fact that, for physiological and social reasons The British Toilet Association recommends the following ratio of provision: Number of male cubicles plus number of male urinals x 2 = required number of female cubicles.

The pattern of use of a building will affect the demand on sanitary facilities and may influence the number, type, and location of facilities provided. In an office, for example, the toilets are likely to be accessed intermittently throughout the day. By contrast, the toilets in an assembly building, such as a theatre, cinema, or entertainment arena will be accessed by a large number of people in a very short time frame, such as immediately before or after the performance, or during the interval. In this case, the number of toilets should be based on the maximum number of people likely to require the facilities at any particular time.

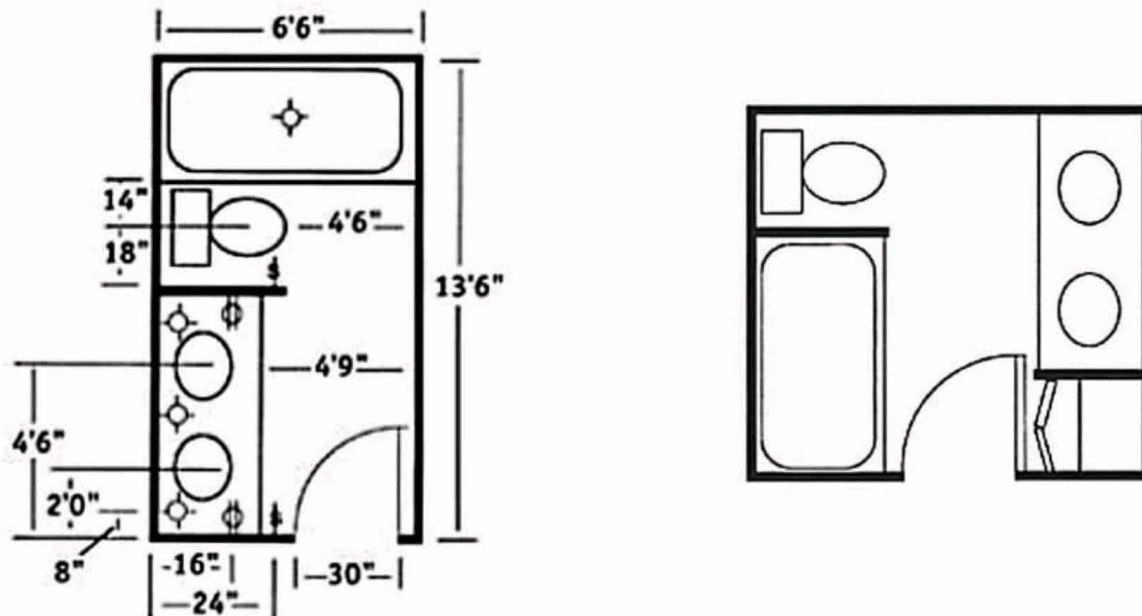

Layout Of Lavatory Blocks

PLUMBING ARRANGEMENT IN A MULTI STORIED BUILDING DISTRIBUTION SYSTEM :

There are four basic methods of distribution of water to a multi-storeyed buildings.

- (i) Direct supply from mains to ablutionary taps and kitchen with WCs and urinals supplied by overhead tanks.
- (ii) Direct Pumping Systems
- (iii) Hydra-pneumatic Systems
- (iv) Overhead Tanks Distribution

Direct Supply System –

This system is adopted when adequate pressure is available round the clock at the topmost floor. With limited pressure available in most city mains, water from direct supply is normally not available above two or three floors. Water is pumped directly into the distribution system without the aid of any overhead tank, except for flushing purposes.

The pumps are controlled by a pressure switch installed on the line. Normally a jockey pump of smaller capacity installed which meets the demand of water switch is installed to restrict the operating cycle during low consumption and the main pump starts when the demand is greater. The start and stop operations are accomplished by a set of pressure switches are installed directly on the line. In some installation, a timer of the pump.

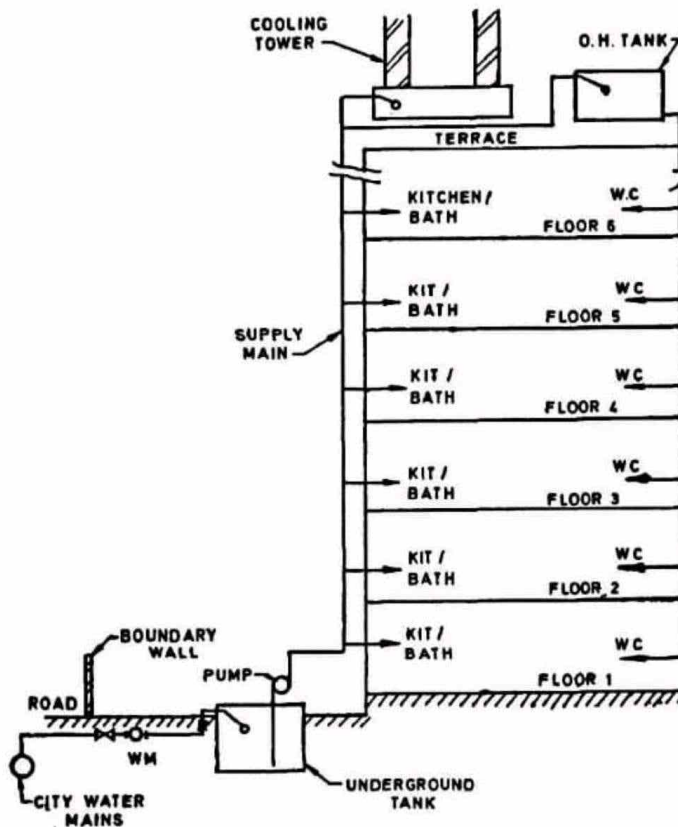

Direct Supply System

ADVANTAGES OF DIRECT PUMPUNG SYSTEM

- (i) Direct pumping systems are suitable for buildings where a certain amount of constant use of water is always occurring. These buildings are all centrally air-conditioned buildings for which a constant make up-supply for air-conditioning cooling towers is required.
- (ii) The system depends on a constant and reliable supply of power. Any failure in the power system would result in a breakdown in the water supply system.
- (iii) The system eliminates the requirements of overhead tanks for domestic purposes (except for flushing) and requires minimum space.

Hydro-pneumatic System

- (i) Hydro-pneumatic system is a variation of direct pumping system. An air-tight pressure vessel is installed on the line to regulate the operation of the pumps.

The vessel is arranged to consist of approximately half the capacity of water. As pumps operate, the incoming water in the vessel compresses the air on top. When a predetermined pressure is reached in the vessel, a pressure switch installed on the vessel switches off the pumps. As water is drawn into the system, pressure falls into the vessel starting the pump at preset pressure. The air in the pressure tank slowly reduces in volume due to dissolution in water and leakages from pipe lines. An air compressor is also necessary to feed air into the vessel so as to maintain the required air-water ratio.

- (ii) There are various types of system available in the market and the designers has to select the system according to the needs of each application.
- (iii) Hydro-pneumatic system generally eliminates the need for an over head tank and may supply water at a much higher pressure than available from overhead tanks particularly on the upper floors, resulting in even distribution of water at all floors.

Overhead Tank Distribution

- (i) This is the most common of the distribution systems adopted by various type of buildings.
- (ii) The system comprises pumping water to one or more overhead tanks placed at the top most location of the hydraulic zone.

SANITARY FIXTURES

In case of buildings various types of sanitary fittings are required to collect the sanitary waste from the building.

The fittings can be classified as below.

(A) Ablution fittings

- Wash basins
- Sinks
- Bath tubs
- Flushing cisterns
- Drinking fountains

(B) Soil fittings

- Water closets
- Urinals
- Slop sinks

All type of sanitary fittings should be fixed against the external wall, so that the buildings can be ventilated with light and air. The floor and wall material should be non-absorbent with curved angle at the junctions.

FLUSHING CISTERNS:-

These are used for flushing water closets and urinals after use.

There are several varieties of flushing cisterns. High level cisterns are intended to operate with a minimum height of 125 cm between the top of the pan and the underside of the cistern. Low-level cisterns are intended to operate at a height not more than 30 cm between the top of the pan and the underside of the cistern.

Cistern may be of cast iron, glazed earthenware, glazed vitreous ware or pressed steel or any other impervious material.

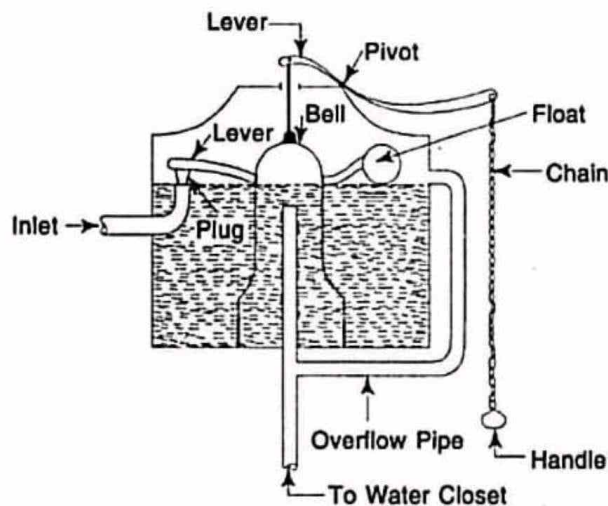

Two common types of cisterns are

- i) Bell type without valve
- ii) Flat bottom type fitted with valve

Figure shows a bell type flushing cistern.

The bell is kept over the outlet pipe, the inlet end of which is slightly above the water level. When the chain is pulled the bell is lifted causing the water to spill over the outlet pipe and starting the siphonic action due to which the whole water rushes towards the outlet and flushes the water closet.

Due to shortage in the water supply, there was urgent demand to reduce the quantity of water consumption. All flushing cisterns available and existing in the building fittings, discharge their full quantity of water even for small purposes even when small quantity of water will be sufficient for that purpose.

WATER-CLOSET

This is a sanitary appliance to receive the human excreta directly and is connected to the soil pipe by means of a trap.

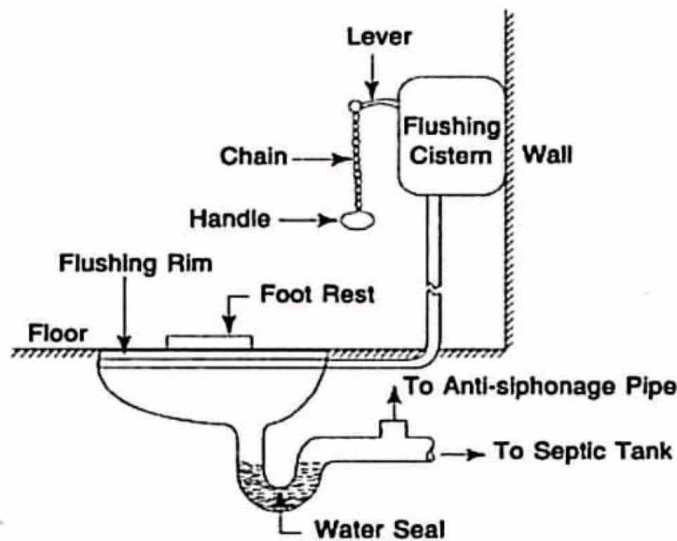

Water Closet
Fig.17. 5

The water closets are classified as follows

(A) SQUATTING TYPE OR INDIAN TYPE

- (I) Long pan pattern (length 4560, 5680, 680 mm)
 - (II) Orissa pattern (length 580,630,680 mm)
 - (III) Rural pattern (length 425 mm)
- (B) Wash-down, pedestal or European type

Figure 17.5 shows the section through an Indian type water closet. This is manufactured in two different pieces. I) squatting type II) trap.

The pan is provided with an integral flushing rim of suitable type. The inside of the bottom of the pan should have sufficient slope towards the outlet for the quick disposal during flushing.

These are made of vitreous china. The inner portion is glazed to make it easy in cleaning. The pan is connected to the flushing cistern by means of flushing pipe. The top of the trap is connected to the anti-siphon or vent pipe.

Figure shows the pictorial view of an Indian type water closet.

Figure shows the section through a wash-down water closet which is most commonly used in high class buildings. It is provided with a wide flushing rim and 5 cm trap. It is one piece construction in which the pan and trap are not separate. It is provided with a water inlet or supply horn for connecting to the flushing pipe. It may be provided with P and S trap as desired. These types of water closets requires less space than squatting pattern type and can be flushed by low level cistern. Now a days siphonic water closets are very popular.

Bowl type urinals are one piece construction, each is provided with two fixing holes on the side for fixing it on the wall. At the bottom an outlet horn is provided for connecting it to the trap. The inside surface is regular and smooth for ensuring efficient flushing. The bottom of the urinals is provided with sufficient slope from the front towards the outlet for efficient drainage of the urinals. Bowl type urinals are also provided with flushing rim which is connected by flushing pipe to the flushing cistern. Figure shows a bowl type urinal.

The slab and stall type of urinals are manufactured either as a urinal or as a range of two or more and are used in public places such as cinema halls, restaurants, railway stations, offices etc.

The squatting type urinals are mostly used in ladies lavatories.

REQUIREMENTS OF SANITARY FITTINGS

The requirement of sanitary fitting depends upon the persons using them and the circumstances, type of building etc

TRAPS

Foul gases produced in the sewers , drains, waste pipes may cause nuisance by entering in the houses through house –connecting pipes. If their passage is not checked by some suitable devices. The devices which are used to stop the escape of foul gases inside or outside the houses are known as traps.

The traps generally consist of a bend tube which provides a water seal between the atmosphere and the sewer gases. The efficiency of the traps depends on the depth of water seal , deeper the seal more efficient will be the trap.

The following are the requirements of a good trap.

- (i) It should be made of non-absorbent material.
- (ii) It should provide sufficient depth of water seal all times (about 50 mm) having large surface area.
- (iii) It should be self-cleaning and should not obstruct the flow of sewage.
- (iv) It should be provided with access door for cleaning.

The water seal of the traps can break due to the following conditions:-

- (i) If there is any crack in the bottom of the seal or the joint is faulty.
- (ii) If for a long time the seal is not in use, it's water will evaporate in the atmosphere.
- (iii) If due to blockage or any other reason there is an increase in the pressure of the sewer gases, it will pass through the water of seal.
- (iv) If partial vacuums are created in the sewer fittings, it will suck up the seal water. To avoid the breakage due to this reason, the portion between the trap and the soil pipe should be connected to the vent pipe.

TYPES OF TRAPS

The following are the types of traps most commonly used

(a) P, Q, and S- TRAPS –

These traps are classified according to their shape. As shown in 17.6 figure. They essentially consist of a U- tube which retains water acting as a seal between the foul gas atmosphere.

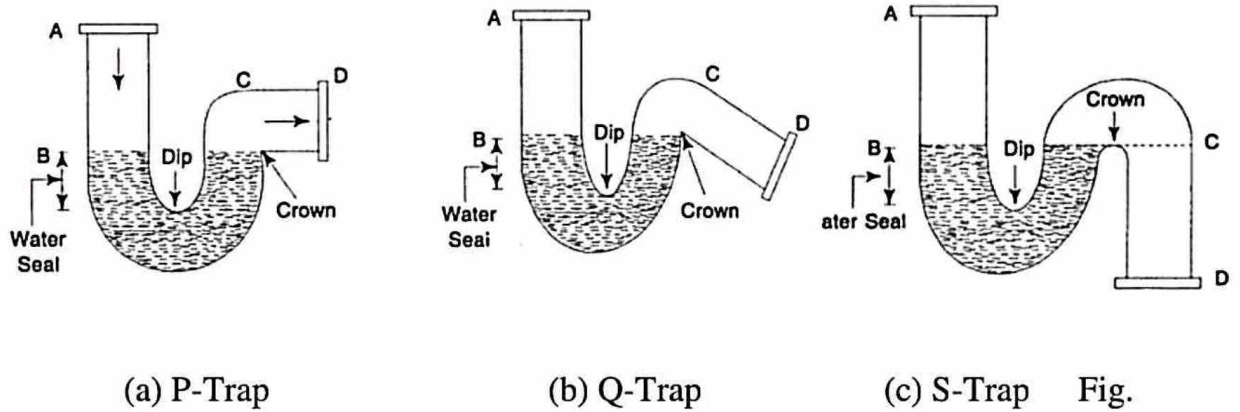
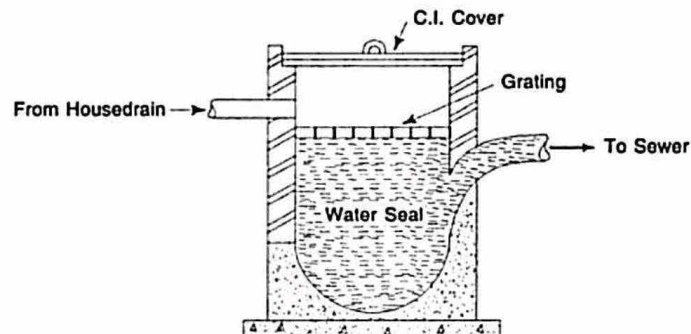

Fig.17.6

(b) Gully traps:-

This trap is provided at different places in the drain pipes. Waste water from sinks, bath etc. Enters in through back inlet and outlet water from the sweeping of the rooms, courtyards etc. Enters from the top, where a coarser screen grating is fitted to check the solid matter. figure shows a gully trap.



Gully Trap

Fig. 17.7

(c) An intercepting trap

The sewage from every house goes in street sewers which carry it away from the city. The street sewers contain foul gases in it and if their passages are not checked from street sewers to the house. They may enter in the house drain and pollute the atmosphere. For this purpose a trap in one inspection chamber is provided outside the houses, which is called an intercepting trap. This trap is provided at the top with a cleaning eye with a plug. Figure shows this type of trap.

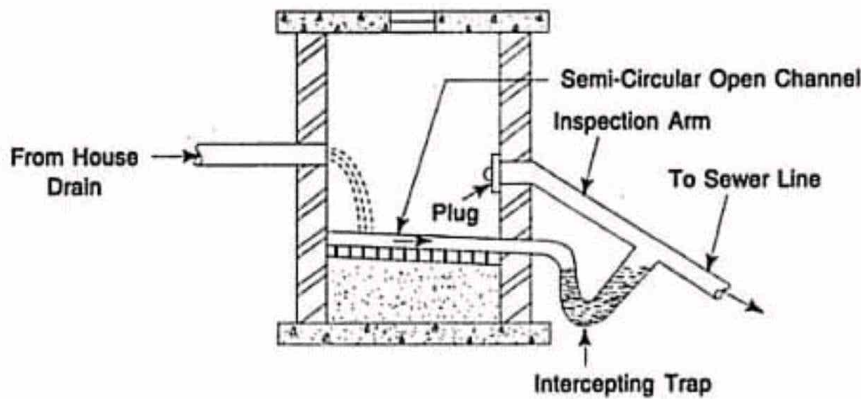

An intercepting trap

Fig.17.8

(d) Anti -D traps

P, Q and S traps are largely used for baths, sinks and lavatories. In such cases, they are made with enlarged mouth so that the waste pipe may be thoroughly flushed out. But in these traps full bore is not interfered with by the discharge. These traps are made of ordinary circular sections. Anti -D pipes are an improvement over the above traps which are made by Mr. Melleyer of England. By a series of experiment Mr. Melleyer found that the driven out of water momentum of the change from the trap can be prevented by so shaping the trap that the water - holding portion is contracted and the outgo is large and square. This trap also prevents siphonic action. The water - way in the anti- D trap is reduced which ensures the removal of all refuse, while the outlet being larger prevents the pipe from filling full and causing siphonic action.

(e) Anti- siphonic trap -

These are several types of anti-siphonic traps in the market, which are also called re -called trap. These traps avoid the connection to the vent pipe and reduce this expensive work. Grevak trap which is most common. The construction of this trap is such that when water seal is subjected to the pull due to the siphonic action, the heavier atmospheric pressure on the inlet side presses the water down and the air can pass from by- **pass tube B**.